

17" TileVision®

Operating Instructions



PORTER LANCASTRIAN LIMITED
www.tilevision.tv

17" Widescreen TileVision®

A Wide Array of Screen Settings

You can choose different screen settings depending on the type of programme you are watching or the surrounding conditions (the lighting or the outside weather conditions). You can switch between Dynamic, Standard, Mild and Game Options, or you can configure the screen settings yourself. You can select 4:3 (normal format), 16:9 (widescreen format), or Zoom (widescreen view of normal format) to match what you are watching to your preference.

A Wide Array of Sound Settings



You can choose an optimal sound setting for the type of program you are watching. You can switch between Flat, Music, Movie, and Speech, or you can configure the settings yourself.

Quick View

Press the QV button to view the last programme you were watching.

Teletext Function

You can display teletext information at any time on your TileVision®.

	CAUTION RISK OF ELECTRIC SHOCK DO NOT OPEN	
<p>WARNING: TO PREVENT INJURY, THIS APPARATUS MUST BE SECURELY ATTACHED TO THE WALL IN ACCORDANCE THE INSTALLATION INSTRUCTIONS.</p> <p>CAUTION: DO NOT REMOVE COVER. NO USER-SERVICEABLE PARTS INSIDE. REFER SERVICING TO QUALIFIED SERVICE PERSONNEL. BEWARE OF STATIC SENSITIVE PARTS.</p>		



This symbol is intended to alert the user to the presence of important operating and maintenance (servicing) instructions in the literature accompanying the appliance.



Safety Instructions

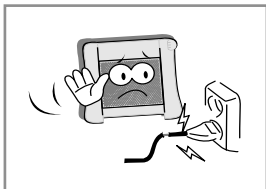

Do not use a damaged socket and do not let the power cord touch a heat source.

– This may cause an electric shock or fire.

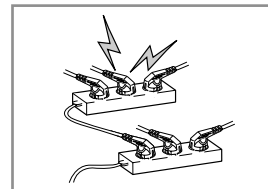

Do not connect too many extension cords or plugs to an outlet.

– This may cause a fire.

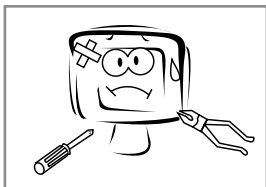

Do not attempt to service the unit.

Contact an authorised dealer or repair service.

– Servicing the unit yourself may cause an electric shock or fire.

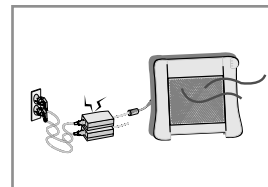

Keep the power adaptor away from any heat source.

– This may cause a fire.

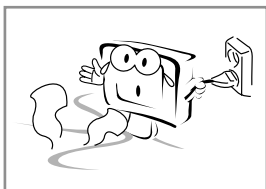

If there are any unusual sounds or smells coming from the unit, unplug it immediately and contact an authorised dealer or repair service.

– This may cause an electric shock or fire.

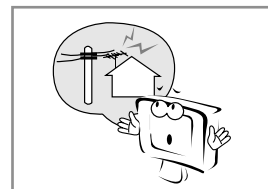

Ensure the antenna is located away from overhead cables.

– This may cause an electric shock.



If an outside antenna is connected to the unit, ensure the external to internal cable entry is fully sealed

– This may cause an electric shock or fire.

Tools Required

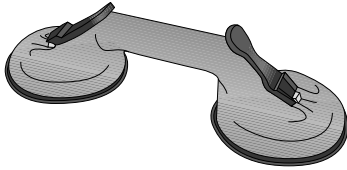

Suction Lifter

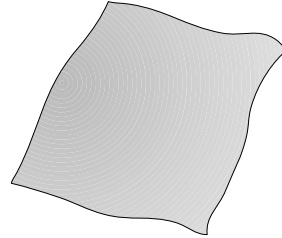

Soft Cloth

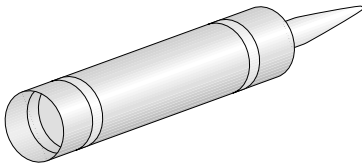

Silicone Sealant



Isopropyl Alcohol

- ☞ Silicone Sealant evolves acetic acid during cure. Use only in well ventilated areas. Irritating to eyes. Wash hands after use and before meals. Wash splashes from skin, clothing and other surfaces. Use a clean cloth. In case of contact with eyes wash immediately with plenty of water.

Please observe safety precautions on the container. Keep out of reach of children and animals.

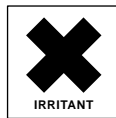

- ☞ Isopropyl alcohol is available from most pharmacies and larger electronics wholesalers. It is an effective degreasing agent.

Please observe safety precautions on the container. Keep out of reach of children and animals. Do not drink.



Table of Contents

Safety Instructions	1
Tools Required	2
Unpacking your TileVision®	4
Your TileVision®	5
Connector Inputs	5
Connections	6
Connecting an Antenna or Cable	7
Connecting to the RCA or S-Video Input	8
Connecting to a DVD or DTV Set-Top Box Input	9
Connecting to the SCART Input	9
Installing the Front Plate	10
The Remote Control	11
Switching the TileVision® On/Off	12
Selecting a Picture from External Sources	12
Selecting your On-screen Language	12
On-screen Menus and Displays	13
Tuning, Setup and Editing Programs	14
Picture Control	17
PC Picture Adjustment	18
Sound Control	19
TV, SCART, S-Video and PC Modes	20
Auto Sleep	20
Blue Back	21
ARC (Aspect Ratio Control)	21
Sleep Timer	22
Sound Output Selection	22
Teletext	23
Displaying the Teletext Information	23
Teletext Button Functions	24
Troubleshooting	25
Specifications	26
Notes	27

Unpacking your TileVision®

Please make sure the following items are included with your TileVision® if any items are missing, contact your dealer.

Accessories

Two boxes supplied –

1. Back Box Assembly – (first fix)

- 2 speakers.
- 2 lengths speaker cable.
- 1 12V DC Adaptor with 4 metre cord.
- 1 AC Power cord – 100–240V.
- 1 stainless steel back box.
- 1 back box installation instructions.

2. Front Assembly – (second fix)

- 1 front plate assembly complete with Velcro sealing strips.
- 1 remote control.
- 1 installation and instruction manual.
- 1 mirror acrylic surround.

Front View



Remote control sensor and indicator

Power Indicator Status

Indicator	Status
Red	Stand-by
Green	Power on
Green blinking	Remote control

Connector Inputs

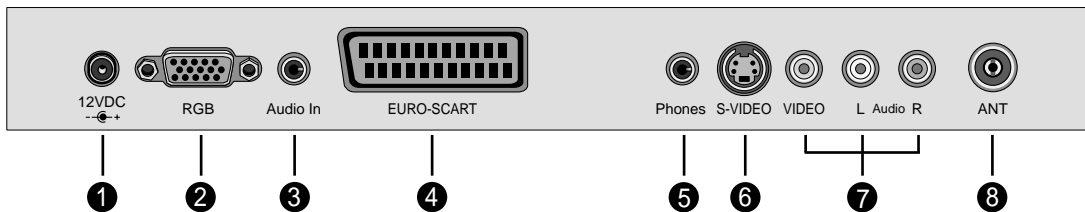

- | | |
|----------------------------|---------------------------|
| ① DC12V Power Input | ⑤ Headphone Output |
| ② RGB Video Input (PC/DTV) | ⑥ S-VIDEO Input |
| ③ Audio Input (PC/DTV) | ⑦ AV Video & Audio Inputs |
| ④ EURO-SCART | ⑧ Antenna Input Jack |

Earthing Points

The Earthing connection points are found on the rear of the front plate and are clearly marked with green labels.

Power Socket

The Power socket (1) is located at the extreme left of the connection array.

Speaker Connections

The speakers should be connected after the Earth straps to the rear of the front plate as detailed on page 10 of these operating instructions.

The speaker connection block is found on the right of the rear of the front plate. Lift one of the lugs and push one conductor of the speaker lead into the connector and release the lug and give the lead a slight pull to make sure that it is gripped correctly. The other wires are connected in the same way.

Note: To ensure that the speakers are in correct phase, the conductor with the stripe should be connected to the negative terminal (L- or R-) and the plain conductor should be connected to the corresponding positive terminal (L+ or R+).

Connections to the speakers terminals should be made in the same way – striped conductor to the negative terminal and positive conductor to the positive terminal.

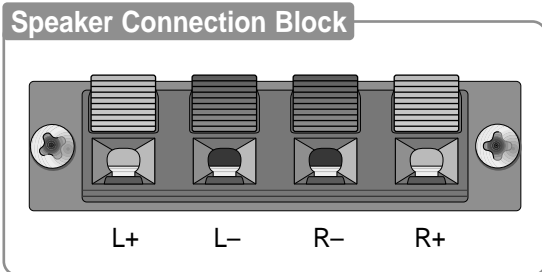

Antenna Feed

The Antenna input jack is found at the extreme right of the connection array (refer to page 7). A minimum signal level of 60dBu/1mV is required to avoid a noisy picture.

Composite Video/EURO-SCART/S-Video/PC/DTV (RGB) Inputs

These are found in the central portion of the connection array. If these inputs are to be utilised the necessary cables must be installed at the same time as the back box (refer to pages 8 and 9 of these instructions).

Note: Careful consideration should be given to use of these inputs prior to the installation of the unit.

Connecting an Antenna or Cable

To view television channels correctly, a signal must be received by the set from one of the following sources: an outdoor antenna, a cable television system or a satellite dish.

- 1 Connect the antenna or input cable to the **75Ω coaxial input** on the rear of the TileVision®.
 - 2 If you are using an indoor antenna, you may need to turn it when tuning your television until you receive a clear picture.
- 👉 **The signal level fed to the set must be at least 60dBu/1mV or the picture may be noisy.**
If in doubt, consult a qualified aerial technician.

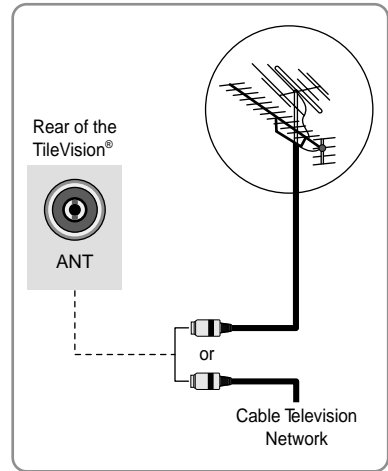

Connecting to the RCA, S-Video and PC/DTV Inputs

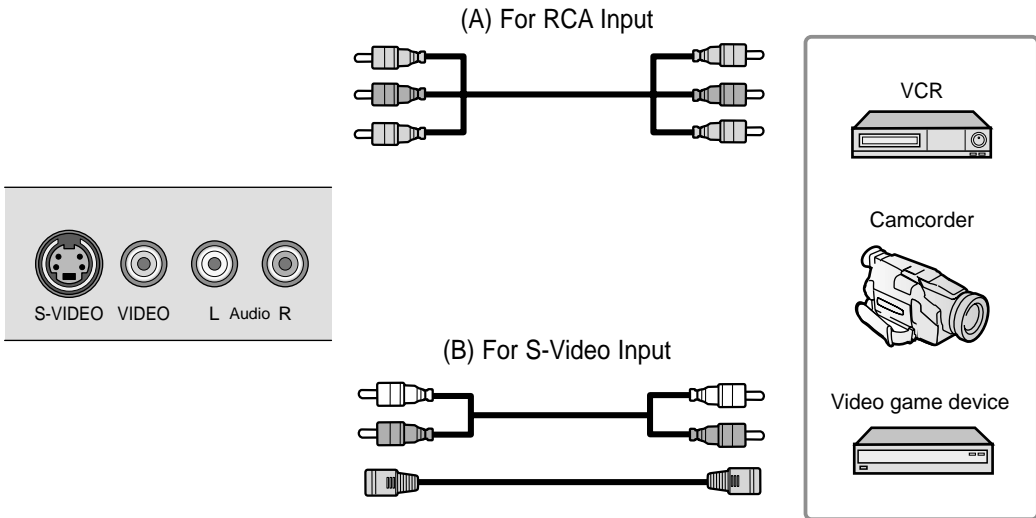

All connections must be made prior to sealing the front plate into the back box.

(A) For RCA Input

1. Connect the RCA cable to the input jacks (video+ audio L/R) on the TileVision® and output jacks on the external equipment such as a VCR, camcorder and some video game devices.

(B) For S-Video Input

1. Connect the S-Video/RCA (audio L/R) cable to the input jacks on the TileVision® and output jacks on the external equipment such as a VCR, camcorder and some video game devices.
2. If the external equipment has mono audio output, connect it only to left jack of the Audio Input/Output.

PC/DTV Input

1. Connect the RGB IN cable (D sub jack) from the RGB output socket of the PC to the PC/DTV input socket of TileVision.
2. Connect the PC Audio IN cable from the PC to the PC Audio IN socket of the TileVision.

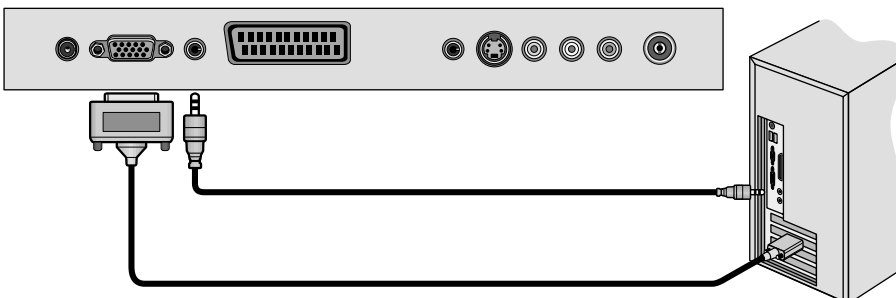

Connecting to the SCART Input

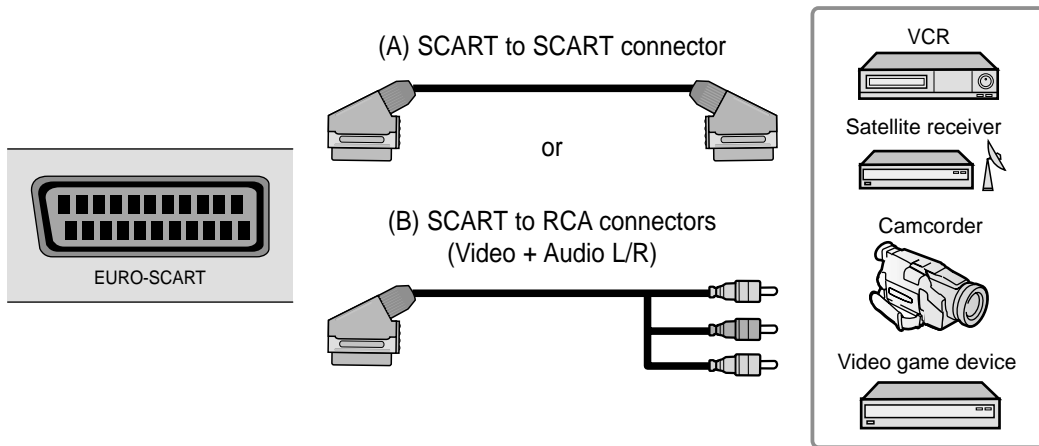

All connections must be made prior to sealing the front plate into the back box.

- ◆ The EURO-SCART connector is used for external equipment with RGB output, such as a VCR, satellite receiver, camcorder, or video game devices.
- ◆ You can select and set one among the two types of cables (A, B) appropriate for the output jack of external device.
- ◆ Insert a 3.5mm stereo jack into the Headphone socket of TileVision to obtain an audio feed which is subject to the TileVision volume controls. This can be connected to the auxiliary input of any audio amplifier which accepts an input from a portable audio device such as a personal CD etc.
- ◆ If the TileVision® is not being installed in a bathroom (i.e. pool-side etc.) insert a 3.5mm stereo jack headphone extension lead into the Headphone socket of TileVision®. The other end of the extension lead can be terminated at a surface mounted socket of the appropriate type.

Installing the Front Plate

Note: A glass carrier/suction lifter is required.

Checking back box prior to installation of front plate

Before commencing the installation of the front plate the polystyrene-blanking panel must be removed from the back box. The next step is to ensure that the appropriate cables and their connectors are present within the back box.

It is important to ensure that the flange inside the back box is cleaned using a grease removal agent and allowing it to dry. The space between the back box and front plate must be even on all 4 sides. If the flange needs to be straightened, this must be done before proceeding any further. This is very important, as any damage will affect the unit's waterproofing capabilities.

Installation of the front plate

Remove the front plate from its packaging and place the remote control to one side, next remove the protective plastic film from the glass.

Introduce the lower front edge of the unit into the box and fit the earth straps to the two Earthing screws as indicated by the green labels on the rear of the front plate. Connect all cables to their respective sockets (refer to pages 6 to 9 of these instructions).

The next step is to remove the soft adhesive protector from the top length of special Velcro, and press the front plate into the back plate (it may be necessary to adjust the position of the cables to achieve a good fit).

The unit installation must comply with all relevant electrical safety regulations before turning the mains supply to the 12V-power adaptor on using the remote pull switch. The unit should now show a red indicator light showing that it is standby mode.

The next step is to tune the unit as detailed on pages 13 and 14.

Once you are satisfied that the unit is tuned and working correctly, press the Power 0/I button to put the unit in standby mode and isolate the unit using the remote pull switch.

Gently remove the front plate using a suction lifter; please do not use a lever to remove the front plate as this will invalidate your guarantee. Next, remove the self-adhesive protectors from the side and bottom Velcro strips and press the front panel into the back box with reasonable force. Take care to apply force to all 4 sides of the box. Restore mains power to the unit using the remote pull switch and press the Power 0/I button to turn the unit on again and check that it is still working correctly.

Sealing the unit

When you are sure that the unit is installed correctly put it in standby mode and apply a clear silicone sealant to the joint between the sides of the back box and the sides of the front plate. Ensure that the silicone is worked into the gap evenly and is applied without any gaps, bubbles, etc. Wipe any excess silicone away; check visually for any gaps or bubbles rectify if necessary. This Seal is of the greatest importance to the reliable and safe operation of this unit and must be waterproof.

Sealing Tip: To achieve a neat seal easily it is good practice to use masking tape around the TileVision® glass screen and the surrounding tiles, just leaving sufficient gap to apply the silicone sealant around the joint between the sides of the back box and front plate.

Note: It is the installer's responsibility to ensure that the TileVision® unit is installed and sealed correctly, failure to do so will invalidate your guarantee. The unit will require cleaning and re-sealing after any servicing/repair operation

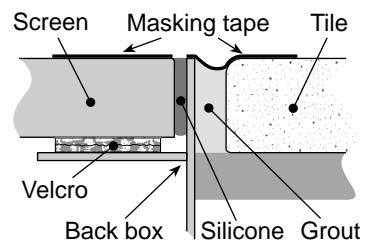

Cleaning Instructions

To clean the front screen, use only a soft damp cloth. Under no circumstances are abrasive cleaners to be used, failure to observe this warning will invalidate your guarantee.

Remote Control

- 1 Power On/Off button**
Turns the TileVision® on or off from standby
- 2 Number buttons**
Selects programme numbers
- 3 PSM (Picture Status Memory) button**
Recalls the preferred picture setting
- 4 VOL (Volume) buttons**
Adjust the volume and selects/adjusts Menu Items
- 5 PR (Programme up/down) button**
Selects next or previous programme or Menu Item
- 6 SSM (Sound Status Memory) button**
Recalls the preferred sound setting
- 7 Mute button**
Turns the sound on or off
- 8 ARC (Aspect Ratio Control) button**
Selects the screen mode – 4:3, 16:9, or Zoom
- 9 OK button**
Accepts your selection or displays the current mode
- 10 Teletext On/Off button**
See page 24 for Teletext function table (buttons 10 to 15)
- 11 Teletext Size button**
- 12 Sleep and Teletext Hold button**
Sets the sleep timer
- 13 Teletext Update button**
- 14 Teletext Reveal button**
- 15 Time and Teletext sub-page button**
Displays the time
- 16 Menu and Red FastText button**
Displays the Main Menu
- 17 Language Select and Green FastText button**
Selects the language during dual language broadcasts. Selects the sound output
- 18 Quick View and Yellow FastText button**
Returns to the previously viewed programme
- 19 TV/AV and Blue FastText button**
Selects between television broadcast, SCART, VIDEO, S-VIDEO, and PC inputs

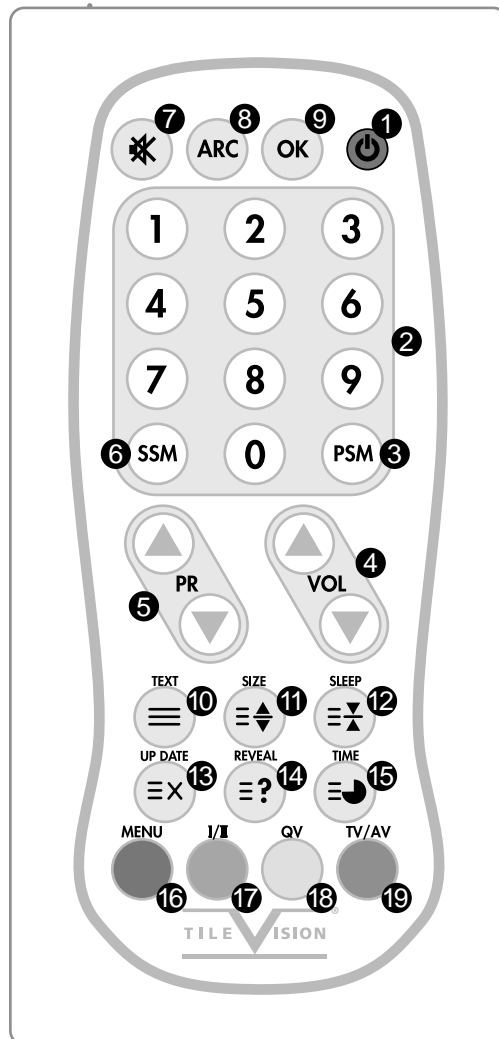

- ☞ - Make sure there are no objects between the remote control and its sensor.
- Don't place the remote control near a heater.
- A strong blow to the remote control may cause it not to operate.

Switching the TileVision® On/Off

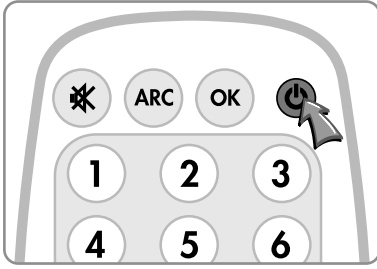

- 1 To switch your TileVision® on, press the **POWER** (🔌) button.
- 2 To switch your TileVision® off, press the **POWER** (🔌) button again.

Selecting a Picture from External Sources

After your various systems (audio and video) have been connected, you can view any of the sources by selecting the appropriate external input.

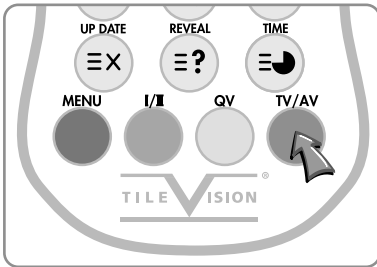

- 1 Make sure all the necessary connections have been made.
- 2 Press the **POWER** (🔌) button to switch the device on.
- 3 Press the blue **TV/AV** button to select required external input mode – Antenna (TV), SCART, VIDEO, S-VIDEO, and PC.

Selecting your On-screen Language

When you start using your TV for the first time, you must select the language in which to display all on-screen menus.

Setup

Auto programme ▶
Manual programme ▶
Programme edit ▶
Language ▶

Language

English
Deutsch
Français
Italiano
Español

- 1 Press the red **MENU** button.
- 2 Press the **PR ▲▼** to select the Setup menu and then press the **VOL ▲** button.
- 3 Press the **PR ▲▼** button to select the Language menu and then press the **VOL ▲** button.
- 4 Press the **PR ▲▼** button to select your desired language and then press the **VOL ▲** button.
- 5 Press the **TV/AV** button.

All the on-screen displays will now appear in the selected language.

On-screen Menus and Displays

- 1 Press the red **MENU** button to display the main menu.
- 2 Press the **PR ▲▼** to select menus.
- 3 Press **VOL ▲▼** to adjust menu items.
- 4 Press **MENU** to go back to the previous menu.
- 5 Press **TV/AV** to exit the menus and confirm settings.

Main menu

Picture
Sound
Special
Setup

Picture

Contrast 90
Brightness 75
Colour 70
Sharpness 50

Sound

Equaliser 0
Balance Off
AVL Off
Surround Off

Special

Input TV
Auto Sleep Off
Blue back Off
ARC 16:9

Setup

Auto programme
Manual programme
Programme edit
Language

Equalizer

Flat
Music
Movie
Speech
User

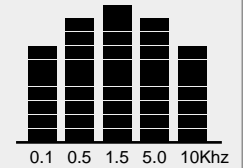

Auto programme

System BG
Storage from 1
Start

Manual programme

System BG
Channel V/UHF 1
Fine
Search
Name C 01
Storage 1

Programme edit

0 C 6	5 C 6
1 C 6	6 C 6
2 C 6	7 C 6
3 C 6	8 C 6
4 C 6	9 C 6
■ Skip	■ Move

Language

English
Deutsch
Français
Italiano
Español



Tuning, Setup and editing TV Programmes

Note: It is recommended that Auto Programme is used when installing TileVision® as all available programmes will be stored.

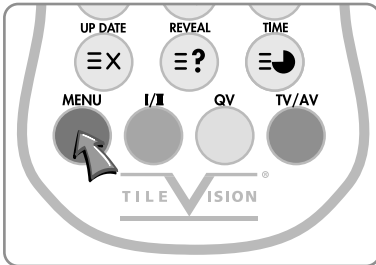

Main menu

Picture
Sound
Special
Setup



Setup

Auto programme
Manual programme
Programme edit
Language



Auto programme

System BG
Storage from 1
Start

Auto Programme

- 1 Press the red **MENU** button.
- 2 Press the **PR ▲▼** button to select the **SETUP** menu and then press the **VOL ▲** button.
- 3 Press the **PR ▲▼** button to select the **Auto Programme** menu and then press the **VOL ▲** button.
- 4 Press the **PR ▲▼** button to select **System**.
- 5 Select a TV system with the **VOL ▲** button:
BG: Germany/Asia/M.East/Africa/Australia
I: UK/Hong Kong/South Africa
DK: CIS/China/East Europe
L: France.
- 6 Press the **PR ▲▼** button to select Storage from.
- 7 Select the beginning programme number with the **VOL ▲▼** button or **NUMBER** buttons.
- 8 Press the **PR ▲▼** button to select Start and press the **VOL ▲** button to confirm. The Auto Programme will now start, this will take a few minutes to complete.
- 9 Press the **TV/AV** button to return to normal TV viewing.

To delete, skip, or move the stored programmes see **Programme Edit**, on page 16.

Tuning, Setup and editing TV Programmes

Manual Programme lets you tune and arrange the programmes in whatever order you desire. You can also assign a programme name with 5 characters for each programme number.

Manual Programme

- 1 Press the red **MENU** button.
- 2 Press the **PR ▲▼** button to select the **SETUP** menu and then press the **VOL ▲** button.
- 3 Press the **PR ▲▼** button to select the **Manual Programme** menu and then press the **VOL ▲** button.
- 4 Press the **PR ▲▼** button to select **System**.
- 5 Select a TV system with the **VOL ▲▼** button:
BG: Germany/Asia/M.East/Africa/Australia
I: UK/Hong Kong/South Africa
DK: CIS/China/East Europe
L: France.
- 6 Press the **PR ▲▼** button to select **Channel**. Press the **VOL ▲▼** button to select **V/UHF** or **Cable** as required. If possible, select the programme number directly with the **NUMBER** buttons.
- 7 Press the **PR ▲▼** button to select **Search**. Press the **VOL ▲▼** button to commence searching. If a channel is found the search will stop.
- 8 Press the **PR ▲▼** button to select **Name**. Press the **VOL ▲** button. You can use a blank, +, -, the digits 0 to 9, and the characters A to Z. You can use the **VOL ▼** button, to select in the opposite direction.
- 9 If this programme is the one required, press the **PR ▲▼** button to select **Storage**. Select the desired programme number with the **VOL ▲▼** button or **NUMBERS** buttons.
- 10 Press the **OK** () button to store it. The display stored will appear.

To store another programme, repeat steps 5 to 10.

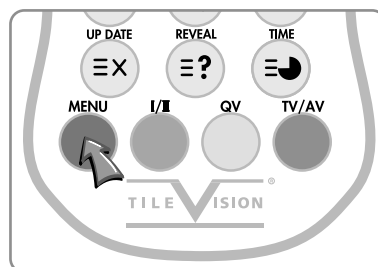

Main menu

Picture ▶
Sound ▶▶▶
Special ▶▶▶
Setup ▶▶▶

Setup

Auto programme ▶▶▶
Manual programme ▶▶▶
Programme edit ▶▶▶
Language ▶▶▶

Manual programme

System		BG
Channel	V/UHF	1
Fine		▶▶▶▶
Search		▶▶▶▶
Name		C 01
Storage		1

Tuning, Setup and editing TV Programmes

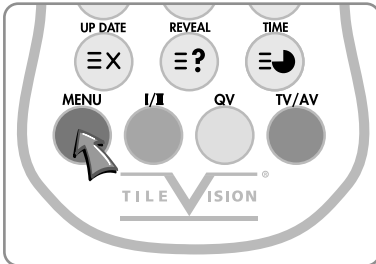

Main menu

Picture
Sound
Special
Setup



Setup

Auto programme
Manual programme
Programme edit
Language



Programme edit

0 C 6	5 C 6
1 C 6	6 C 6
2 C 6	7 C 6
3 C 6	8 C 6
4 C 6	9 C 6
■ Skip	■ Move

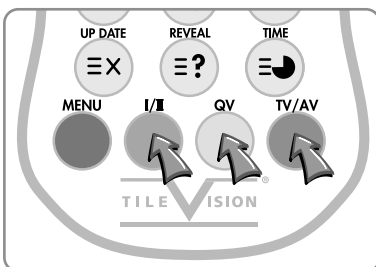

Programme Edit

This function enables you to delete or skip the stored programmes. Also you can move channels to different programme numbers, or insert blank programme data into the selected programme number.

- 1 Press the red **MENU** button.
- 2 Press the **PR ▲▼** button to select the **SETUP** menu and then press the **VOL ▲** button.
- 3 Press the **PR ▲▼** button to select **Programme Edit** and then press the **VOL ▲** button.
- 4 Select the programme name to edit with the **PR ▲▼** button and **VOL ▲▼** button.

Skipping a Programme number

- 1 Select a programme to be deleted with the **PR ▲▼** or **VOL ▲▼** button.
- 2 Press the **GREEN** button. The skipped programme turns to blue.
- 3 Press the **GREEN** button again to release the skipped programme.

Moving a programme

- 1 Select a programme to be moved with the **PR ▲▼** or **VOL ▲▼** button.
- 2 Press the **YELLOW** button.
- 3 Move the programme to the desired programme number with the **PR ▲▼** or **VOL ▲▼** button.
- 4 Press the **YELLOW** button again to release this function.
- 5 Press the **TV/AV** button to return to normal TV viewing.

Picture Control

You can adjust picture Contrast, Brightness, Colour and Sharpness to the levels you prefer.

Manual Picture Control

- 1 Press the red **MENU** button.
- 2 Press the **PR ▲▼** button to select the **Picture** menu and then press the **VOL ▲** button.
- 3 Press the **PR ▲▼** button to select a picture item.
- 4 Press the **VOL ▲▼** button to adjust the picture setting to your requirement.
- 5 Press the **TV/AV** button to store your personal preferences in **User**.

Main menu

Picture ▶
 Sound ▶▶
 Special ▶▶▶
 Setup ▶▶▶▶

Picture

Contrast 90
 Brightness 75
 Colour 70
 Sharpness 50

Selected Item	Setting Change
Contrast	Less Contrast VOL ▼ 0–100 ▲ VOL More Contrast
Brightness	Darker VOL ▼ 0–100 ▲ VOL Brighter
Colour	Lower Colour Intensity VOL ▼ 0–100 ▲ VOL Higher Colour Intensity
Sharpness	Soft picture VOL ▼ 0–100 ▲ VOL Sharp Picture

Auto Picture Control

The Picture options – Dynamic, Standard, Mild, and Game are programmed for optimum picture reproduction at the factory and cannot be changed.

PSM (Picture Status Memory)

- 1 Press the **PSM** (PSM) button.
- 2 Press the (PSM) button repeatedly. Each press of the button changes the screen display as below:

Dynamic → Standard → Mild → Game → User

- **Dynamic:** Vivid Picture.
- **Standard:** Standard Picture.
- **Mild:** Softer Picture.
- **Game:** External Video Game Picture Setup.
- **User:** Manual Picture Setup.

- 3 Press the (OK) button.

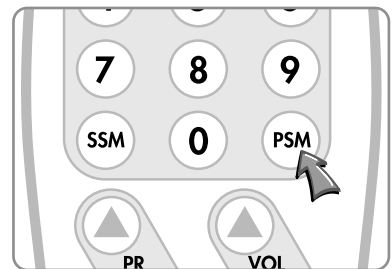

PC Picture Adjustment

You can adjust picture Contrast, Brightness, Temperature, Horizontal/Vertical position, Clock, Phase, Auto and Reset as you prefer.

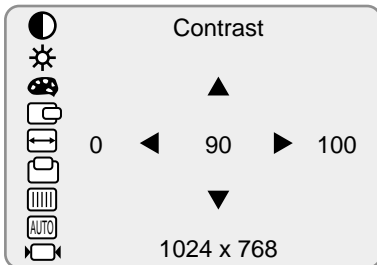

- 1 Press the **TV/AV** button to select the PC mode.
- 2 Press the red **MENU** button.
- 3 Press the **PR ▲▼** button to select the desired picture item.
- 4 Press the **VOL ▲▼** button to make appropriate adjustments.
- 5 Press the TV/AV button to store the adjustment.

- Contrast
- Brightness
- Temperature
- H-position
- V-position
- Clock
- Phase
- Auto
- Reset

Mode	Resolution	Horizontal frequency (KHz)	Vertical frequency (KHz)
VGA	640 x 480	31.5 KHz	60 Hz
	640 x 480	35.0 KHz	67 Hz
	640 x 480	37.9 KHz	72 Hz
	640 x 480	37.5 KHz	75 Hz
	640 x 480	43.5 KHz	85 Hz
	720 x 400	31.5 KHz	70 Hz
SVGA	800 x 600	35.2 KHz	56Hz
	800 x 600	37.9 KHz	60 Hz
	800 x 600	48.1 KHz	72 Hz
	800 x 600	46.9 KHz	75 Hz
	800 x 600	53.7 KHz	85 Hz
XGA	1024 x 768	48.4 KHz	60 Hz
	1024 x 768	56.5 KHz	70 Hz
	1024 x 768	60.2 KHz	75 Hz
	1024 x 768	68.7 KHz	85 Hz

Contrast – adjusts the balance between light and dark areas of the picture.

Brightness – makes the picture darker or brighter as preferred.

Temperature – adjusts the 'warmth' of the image colour (colour temperature).

Horizontal/Vertical Position – adjusts the picture to left/right and up/down as required.

Clock – allows adjustment to minimise any vertical bars or stripes visible on the screen background. The horizontal screen size will also change.

Phase – allows the removal of any horizontal noise. The images of characters can also be sharpened.

Auto – is for the automatic adjustment of the screen position, clock and clock phase. The displayed image will blank for a few seconds whilst auto-configuration is in progress.

Reset – restores the factory programmed settings.

✎ Signals from some graphics cards may not lock properly. If the results are unsatisfactory, adjust the clock and clock phase manually.

If the set is cold, there may be a small 'flicker' when first switched on. This is normal, there is nothing wrong with the equipment.

Some red, green and blue dot effects may appear. This is caused by aliasing and has no impact on the equipment.

Sound Control

Preferred sound setting can be selected; Flat, Music, Movie or Speech.

Manual Sound Control

Equaliser mode can be manually adjusted by cutting and boosting the five selected frequency bands, then storing the settings as User. Balance can be adjusted.

AVL, when switched on, will automatically keep an equal volume level, even when changing programmes.

- 1 Press the red **MENU** button.
- 2 Press the **PR ▲▼** button to select the **Sound** menu, and then press the **VOL ▲** button.
- 3 Press the **PR ▲▼** button to select the desired sound item: **Equalizer**, **Balance**, **AVL**, or **Surround**, then press the **VOL ▲** button.
- 4 Press the **VOL ▲▼** button to make desired adjustment.
- 5 Press the **VOL ▲** button in **Equalizer** to set the **Equalizer**.
- 6 Press the **PR ▲▼** button to select the preferred setting; **Flat**, **Music**, **Movie**, **Speech**, or **User**. To set the **Equalizer User**:
 - a) Select User by pressing the **PR ▲▼** button.
 - b) Select a sound band by pressing the **VOL ▲▼** button.
 - c) Make the desired sound level adjustment with the **PR ▲▼** button.
 - d) Press the **MENU** button to return to the preceding menu, and the **TV/AV** button to return to normal TV viewing.

Auto Sound Control

The sound settings for **Flat**, **Music**, **Movie**, and **Speech** are programmed at the factory for optimum sound reproduction, and cannot be changed.

SSM (Sound Status Memory)

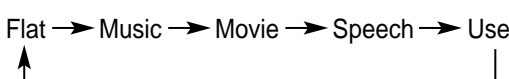
- 1 Press the **SSM** (SSM) button.
- 2 Press the (SSM) button repeatedly to select.
Each press of the button changes the screen display as below.
Flat → Music → Movie → Speech → User

- 3 Press the (OK) button.

Main menu

Picture ▶
Sound ▶▶▶
Special ▶▶▶
Setup ▶▶▶

Sound

Equaliser ▶
Balance 0
AVL Off
Surround Off

Equalizer

Flat
Music
Movie
Speech
User

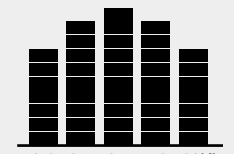

0.1 0.5 1.5 5.0 10kHz

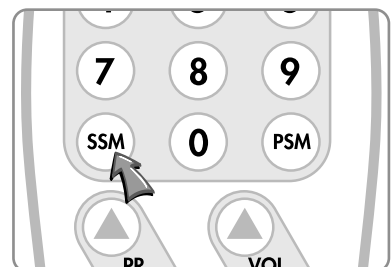

TV, SCART, Video, S-Video and PC Modes

TV, SCART, Video, S-Video or PC inputs can be selected by pressing the TV/AV button repeatedly.

Main menu

Picture
Sound
Special
Setup



Special

Input
Auto Sleep
Blue back
ARC

TV
Off
Off
16:9

Alternatively the external equipment inputs can be selected via the **Special** menu.

- 1 Press the red **MENU** button.
- 2 Press the **PR ▲▼** button to select the **Special** menu, and then press the **VOL ▲** button.
- 3 Press the **PR ▲▼** button to select Input.
- 4 Press the **VOL ▲▼** button to select **TV, SCART, Video** and **S-Video**.
- 5 To return to TV mode, press the **TV/AV** button repeatedly.

Auto Sleep

Main menu

Picture
Sound
Special
Setup



Special

Input
Auto Sleep
Blue back
ARC

TV
Off
Off
16:9

If you select **Auto Sleep On** the TileVision® will automatically switch itself to standby mode approximately ten minutes after a TV channel stops broadcasting.

- 1 Press the red **MENU** button.
- 2 Press the **PR ▲▼** button to select the **Special** menu, and then press the **VOL ▲** button.
- 3 Press the **PR ▲▼** button to select **Auto Sleep**.
- 4 Press the **VOL ▲▼** button to select **On**.
- 5 Press the **TV/AV** button to return to the normal TV viewing.

Blue Back

If you select **Blue Back On** any programme without a signal will appear in blue on the screen.

- 1 Press the red **MENU** button.
- 2 Press the **PR ▲▼** button to select the **Special** menu, and then press the **VOL ▲** button.
- 3 Press the **PR ▲▼** button to select **Blue Back**.
- 4 Press the **VOL ▲▼** button to select **On**.

Main menu

Picture
Sound
Special
Setup



Special

Input	TV
Auto Sleep	Off
Blue back	Off
ARC	16:9

ARC (Aspect Ratio Control)

- 1 Press the **ARC** (ARC) button.

The image will change as shown below whenever you press the **ARC** button.

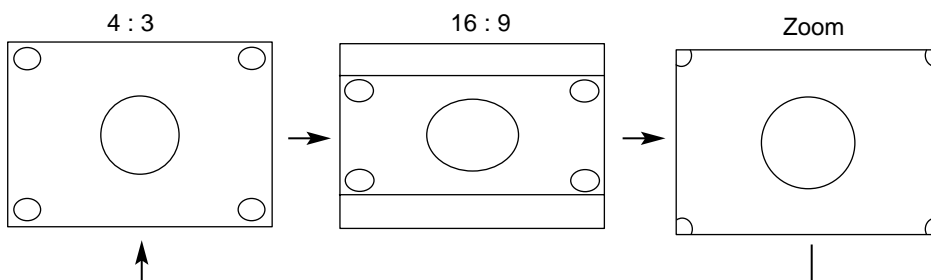

Sleep Timer

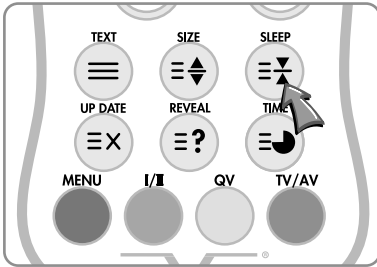

The sleep timer automatically switches the TileVision® to standby after the preset time elapses.

- 1 Press the **SLEEP** button repeatedly to select the number of minutes.
- 2 The display will appear on the screen followed by **0, 10, 20, 30, 60, 90, 120, 180** and **240**.
- 3 The timer begins to countdown from the number of minutes selected.
- 4 To view the remaining sleep time, press the **SLEEP** button once.
- 5 To cancel the sleep time, repeatedly press the **SLEEP** button until the display disappears.

Sound Output Selection

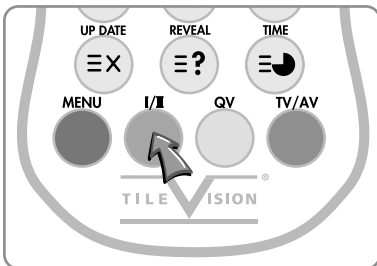

In **VIDEO** mode you can select output sound for the left and right loudspeakers.

Repeatedly press the **I/II** button to select the sound output.

L+R: Audio from audio L input is sent to left loudspeaker and audio signal from audio R is sent to right loudspeaker.

L+L: Audio Signal from audio L input is sent to left and right loudspeakers.

R+R: Audio Signal from audio R input is sent to left and right loudspeakers.

Teletext

The Teletext page of most TV channels provide information such as TV programme times, News bulletins, Weather forecasts, Travel information, or Sports results.

Functions of Teletext:

Part Display Contents

- A Selected page number.
- B Broadcast Station identity.
- C Current page number or searching status.
- D Date and time.
- E Text information.
- F FasText information.
Red, Green, Yellow, Blue

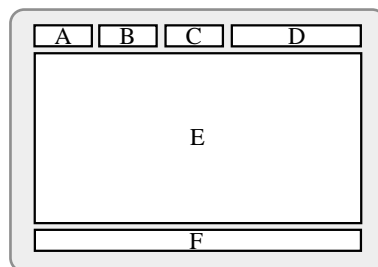

Displaying the Teletext Information

Text On/Off

- 1 Press **TEXT** (≡) button once, displays the Teletext pages.
- 2 Press **TEXT** button again, displays the Teletext pages superimposed on the TV picture.
- 3 Press **TEXT** button once more to switch off the Teletext, TV mode appears.

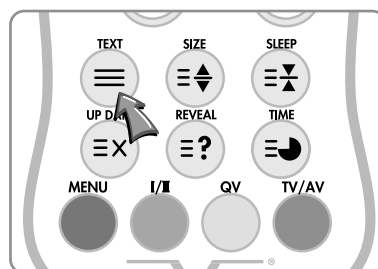

FasText

The Teletext pages are colour coded along the bottom of the screen and are selected by pressing the corresponding coloured button on the remote control.

Page Selection



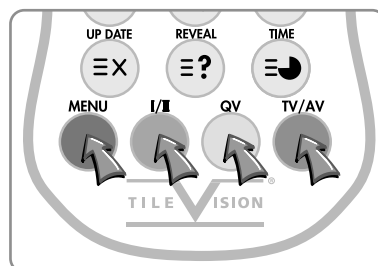

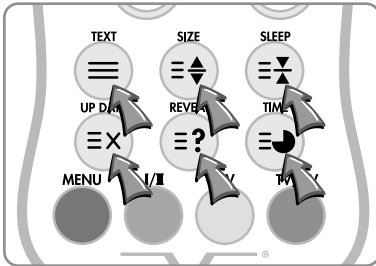

- 1 Select the pages, which are colour coded along the bottom line of the Teletext page, with the same coloured buttons on the remote control.
- 2 The **VOL ▲▼** buttons can be used to select the preceding or following page.



Teletext Button Functions



The table below gives a complete explanation of each of the Teletext buttons.

<i>Button</i>	<i>Menu</i>	<i>Functions</i>
	TEXT	Activates Teletext mode, press again to display teletext page superimposed on the TV picture. Press again to return to TV mode.
	SIZE	Selects double height text. Press button to enlarge top half of the page. Press again to enlarge the bottom half of the page. Press again to return to normal size text.
	SLEEP (hold)	Stops the automatic page change, which occurs if a Teletext page consists of two or more sub pages. Stop symbol is displayed in the top left hand corner of the screen. Press the button again to resume.
	UPDATE	Displays the TV picture on the screen while waiting for the new Teletext page. The display will appear at the top left hand corner of the screen. When the updated page is available then the display will change to the page number. Press the UPDATE button to view the updated Teletext page.
	REVEAL	Press this button to display concealed text, such as answers to quiz games. Press the button again to remove the information from the display.
	TIME	When viewing a TV programme, press this button to display the time at the top right hand corner of the screen. Press the button again to remove the display. In Teletext mode press this button to select and hold or change a four digit sub page number. This is displayed along the bottom of the screen. Press the button again to exit this function.

Troubleshooting

No picture or sound.

- ✎ Make sure the AC power cord is connected to the 12V power adapter.
- ✎ Make sure the 12V DC power cord is connected to the TileVision®.
- ✎ Check for power failure.

Screen is black.

- ✎ Make sure the external signal source mode is selected.
- ✎ Press the signal input button (**TV/AV**) to change to TV.

Picture is OK but there is no sound.

- ✎ Press the **Mute** button.
- ✎ Check another channel.
- ✎ Press the button to increase the volume.
- ✎ Check the speaker connections from the TileVision® to the speakers.

Poor sound quality.

- ✎ Make sure the channel is broadcasting in stereo.
Press the **I/II** button to Select Mono. The sound quality of a stereo broadcast may be poor in a weak signal area.
(See page 19)

No image on a specific channel.

- ✎ Make sure the channel selection is correct.
- ✎ Change the antenna direction to the right or left.
- ✎ Adjust the fine tuning of the channel.

Image is not stable and may appear to vibrate, horizontal bars appear.

- ✎ Adjust the fine tuning of the channel.
- ✎ Make sure there is no powerful electromagnetic wave interference from the transmitting station.
- ✎ Stop using a hair drier, electric drill or electric blender.

No colour on a specific channel (a black & white image).

- ✎ Check other channels to see if the specific channel is broadcasting a black & white program.
- ✎ Adjust the colour. (See page 17)

Black or white dots appear on all channels or a specific channel.

- ✎ Make sure the antenna is connected correctly. (See page 7)
 - ✎ Make sure the status of the antenna or wire is good.
 - ✎ Adjust the fine tuning of the channel.
-

Specifications – TV/17/FR2

Model name		TV/17/FR2
LCD	Size	17.1" Diagonal
	Display Size	400 mm (H) x 258 mm (V)
	Pixel Pitch	0.291mm (H)/0.291 mm (V)
	Pixel Number	1,280 x 768 pixels RGB stripe arrangement
	Colour Depth	8 bits (16.7 million colours)
	Type	a-si TFT active matrix
	Brightness	550 cd/m ²
	Contrast Ratio	600:1
	Viewing Angle	178° typ (L/R & U/D)
TV/VIDEO	Colour System	PAL/SECAM or NTSC only
	Sound System	B/G, D/K, I, M, L
	Video System	CVBS, S-VHS, RGB
SCART	Video Input	1.0 Vp-p @ 75 ohm
	Audio Input	500 mv rms
	RGB Input	0.7 Vp-p @ 75 ohm
Audio Output		2.5 W x 2
Power Supply		12 VDC/60 W
Power Consumption		Max. 50 W
Dimension (WxHxD)		483 mm x 353 mm x 75 mm
Weight of Fitted Assembly		11.7 Kg
Accessories		Remote Control (2), Operating Instructions, Power Cord, DC Adaptor, Speaker (2), Speaker Cable (2), Back Box, Front Plate

 Design and specifications are subject to change without notice.



PORTER LANCASTRIAN LIMITED
www.tilevision.tv