

TILEVISION® 17

Operating Instructions

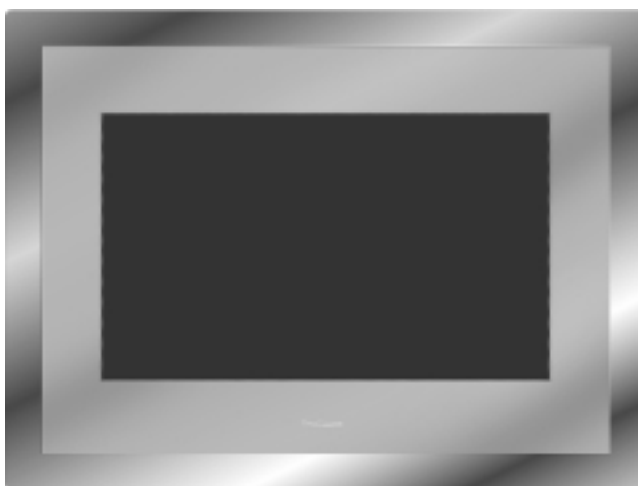

TileVision® is Designed and Manufactured by:



PORTER LANCASTRIAN LIMITED

www.tilevision.tv

17" Widescreen TileVision®

A Wide Array of Screen Settings

You can choose different screen settings depending on the type of programme you are watching or the surrounding conditions (the lighting or the outside weather conditions). You can switch between Dynamic, Standard, Mild and Game Options, or you can configure the screen settings yourself. You can select various picture formats; 16:9, 14:9, 4:3, 16:9 Zoom, 14:9 Zoom, 4:3 Zoom or Auto, to match the content you are watching to your preference.

A Wide Array of Sound Settings

You can choose an optimal sound setting for the type of program you are watching. You can switch between Flat, Music, Movie, and Speech, or you can configure the settings yourself.

Quick View



Press the QV button to view the last programme you were watching.

Teletext Function

You can display teletext information at any time on your TileVision®.

FM Radio Function

Tune in to your favourite FM radio stations by selecting the Radio Mode.

	CAUTION RISK OF ELECTRIC SHOCK DO NOT OPEN	
<p>WARNING: TO PREVENT INJURY, THIS APPARATUS MUST BE SECURELY ATTACHED TO THE WALL IN ACCORDANCE WITH THE INSTALLATION INSTRUCTIONS.</p> <p>CAUTION: DO NOT REMOVE COVER. NO USER-SERVICEABLE PARTS INSIDE. REFER SERVICING TO QUALIFIED SERVICE PERSONNEL. BEWARE OF STATIC SENSITIVE PARTS.</p>		



This symbol is intended to alert the user to the presence of important operating and maintenance (servicing) instructions in the literature accompanying the appliance.

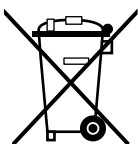

Waste Electrical and Electronic Equipment (WEEE) Directive

In the European Union, this symbol indicates that this product should not be disposed of with household waste. It should be deposited at an appropriate facility to enable recovery and recycling.

Safety Instructions

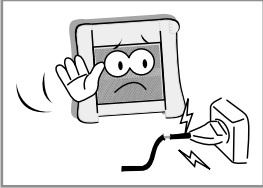

Do not use a damaged socket and do not let the power cord touch a heat source.

– This may cause an electric shock or fire.

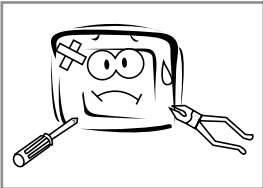

Do not attempt to service the unit.

Contact an authorised dealer or repair service.

– Servicing the unit yourself may cause an electric shock or fire.

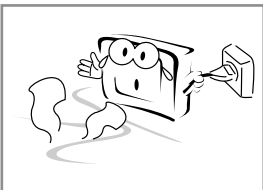

If there are any unusual sounds or smells coming from the unit, unplug it immediately and contact an authorised dealer or repair service.

– This may cause an electric shock or fire.



If an outside antenna is connected to the unit, ensure the external to internal cable entry is fully sealed

– This may cause an electric shock or fire.

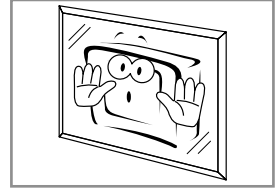

Do not add an additional screen or cover the TileVision's glass.

– The heated screen prevents condensation forming in steamy rooms and covering the screen may cause the unit to overheat.

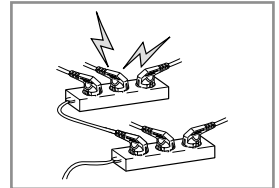

Do not connect too many extension cords or plugs to an outlet.

– This may cause a fire.

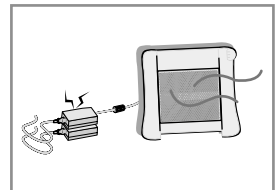

Keep the power adaptor away from any heat source.

– This may cause a fire.

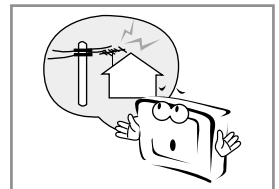

Ensure the antenna is located away from overhead cables.

– This may cause an electric shock.

FAILURE TO OBSERVE THE ABOVE SAFETY WARNINGS MAY INVALIDATE THE WARRANTY

Tools Required

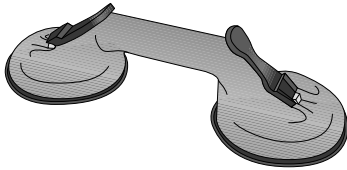

Suction Lifter

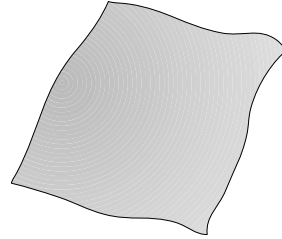

Soft Cloth

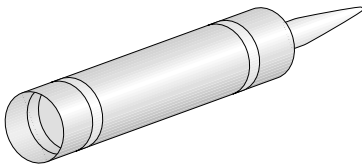

Silicone Sealant



Isopropyl Alcohol

- ☞ **Silicone Sealant produces acetic acid during cure. Use only in well ventilated areas. Irritating to eyes. Wash hands after use and before meals. Wash splashes from skin, clothing and other surfaces. Use a clean cloth. In case of contact with eyes wash immediately with plenty of water.**

Please observe safety precautions on the container. Keep out of reach of children and animals.



- ☞ **Isopropyl alcohol is available from most pharmacies and larger electronics wholesalers. It is an effective degreasing agent.**

Please observe safety precautions on the container. Keep out of reach of children and animals. Do not drink.



Table of Contents

Safety Instructions	1
Tools Required	2
Unpacking your TileVision®	4
Your TileVision®	5
Connector Inputs	5
Connections	6
Connecting an Antenna or Cable	7
Connecting to the S-Video, PC/DTV and PC/DVI Inputs	8
Connecting to the SCART Inputs	9
Installing the Front Plate	10
The Remote Control	11
Switching the TileVision® On/Off	12
Selecting a Picture from External Sources	12
Selecting your On-screen Language	12
On-screen Menus and Displays	13
Tuning, Setup and Editing Programs	14
Picture Control	18
Sound Control	19
PC Picture Adjustment	21
PC Sound Adjustment	23
Clock	24
Blue Back	24
Auto Sleep	25
Child Lock	25
Radio	25
ARC (Aspect Ratio Control)	26
Radio Tuning and Setup	27
Calling the Programme List	28
Teletext	29
Displaying the Teletext Information	29
Teletext Button Functions	30
Troubleshooting	31
Specifications	32
Notes	33

Unpacking your TileVision®

Please make sure the following items are included with your TileVision®.

- 1 TileVision® glass front plate assembly – complete with Velcro fixing strips.
- 1 waterproof remote control.
- 1 standard full function remote control.
- 1 installation and instruction manual.
- 1 mirror acrylic surround.
- 1 remote control holder.

If any items are missing, contact your dealer.

Front View

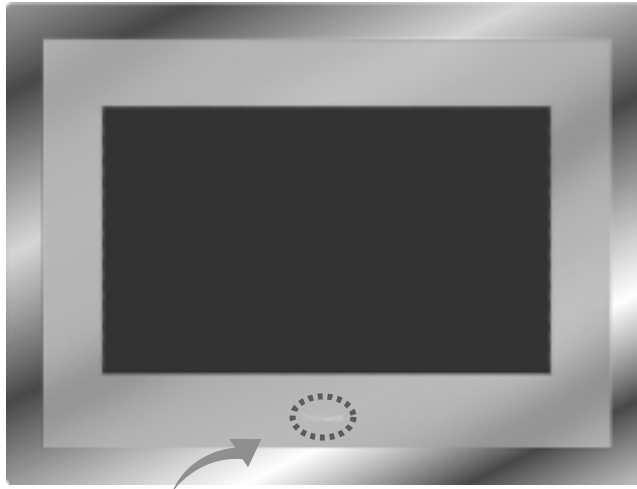

Remote control sensor and indicator

Power Indicator Status

Indicator	Status
Red	Stand-by
Green	Power on
Red blinking	Remote control

Connector Inputs

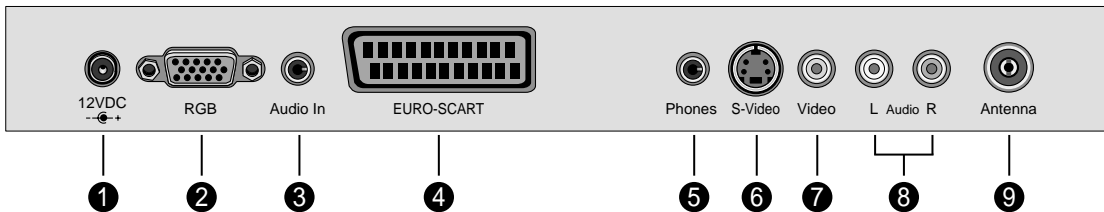

- ① DC12V Power Input
- ② PC/DTV Input (D-SUB)
- ③ PC Audio Input
- ④ EURO-SCART (RGB, FB, AV In, AV Out)
- ⑤ Headphone Output
- ⑥ S-VIDEO Input
- ⑦ Composite Video Input
- ⑧ Audio Inputs (R, L (Mono))
- ⑨ Antenna Input

Earthing Points

The Earthing connection points are found on the rear of the front plate and are clearly marked with green labels. Connect the earthing cables from the back box to these points.

Power Socket

The Power socket (1) is located at the extreme left of the connection array.

Speaker Connections

The speakers should be connected after the Earth straps to the rear of the front plate as detailed on page 10 of these operating instructions.

The speaker connection block is found on the right of the rear of the front plate. Lift one of the lugs, push one conductor of the speaker lead into the connector, release the lug and give the lead a slight pull to make sure that it is gripped correctly. The other wires are connected in the same way.

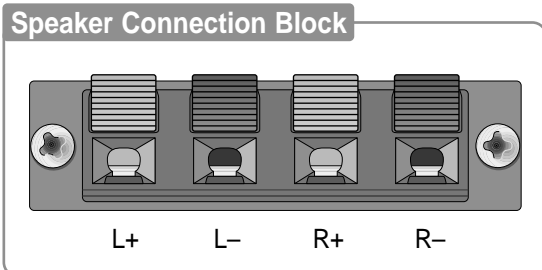

Note: To ensure that the speakers are in correct phase, the conductor with the stripe should be connected to the negative terminal (L- or R-) and the plain conductor should be connected to the corresponding positive terminal (L+ or R+).

Connections to the speakers terminals should be made in the same way – striped conductor to the negative terminal and plain conductor to the positive terminal.

Antenna Feed

The Antenna input jack is found at the extreme right of the connection array (refer to page 7). A minimum signal level of 60dBu/1mV is required to avoid a noisy picture.

Additional connections

Connectors for; PC/DTV (D-SUB), Audio, SCART, Headphones, S-Video, Composite Video, and Audio are found in the central portion of the connection array. If these inputs are to be utilised the necessary cables must be installed at the same time as the back box (refer to pages 8 and 9 of these instructions).

Note: Careful consideration should be given to use of these inputs prior to the installation of the unit.

Connecting an Antenna or Cable

To view television channels correctly, a signal must be received by the set from one of the following sources: an outdoor antenna, a cable television system or a satellite dish.

- 1 Connect the antenna or input cable to the **75Ω coaxial input** on the rear of the TileVision®.
- 2 If you are using an indoor antenna, you may need to turn it when tuning your television until you receive a clear picture.
 - ✎ The signal level fed to the set must be at least **60dBu/1mV** or the picture may be noisy.
If in doubt, consult a qualified aerial technician.

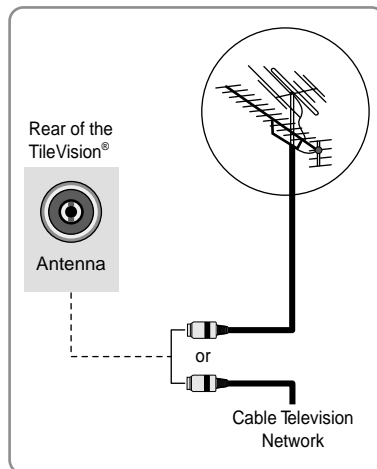

Connecting to the S-Video and PC/DTV Inputs

All connections must be made before sealing the front plate into the back box.

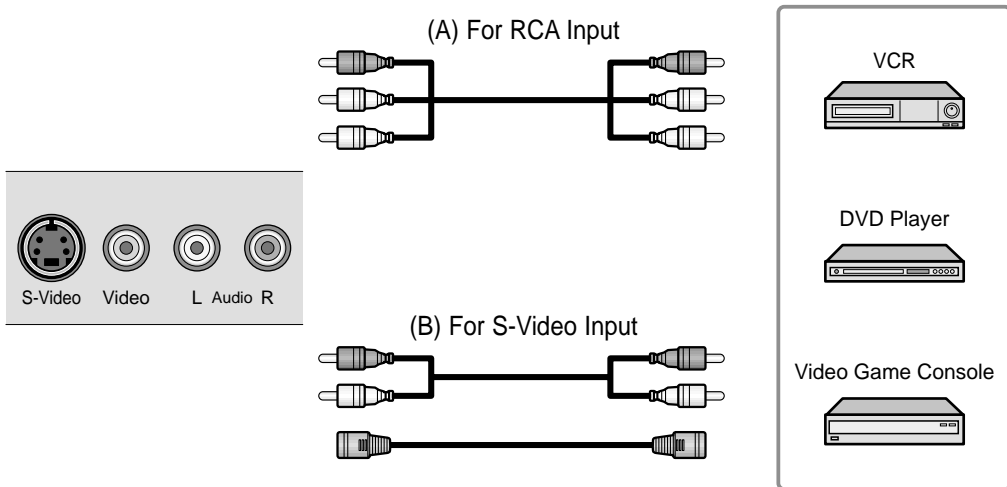

All connections must be made prior to sealing the front plate into the back box.

(A) For RCA Input

- 1 Connect the RCA cable to the input jacks (video+ audio L/R) on the TileVision® and output jacks on the external equipment such as a VCR, camcorder and some video game devices.

(B) For S-Video Input

- 1 Connect the S-Video/RCA (audio L/R) cable to the input jacks on the TileVision® and output jacks on the external equipment such as a VCR, camcorder and some video game devices.
- 2 If the external equipment has mono audio output, connect it only to left jack of the Audio Input/Output.

PC/DTV Input

- 1 Connect the RGB IN cable (D sub jack) from the RGB output socket of the PC to the PC/DTV input socket of TileVision.
- 2 Connect the PC Audio IN cable from the PC to the PC Audio IN socket of the TileVision.

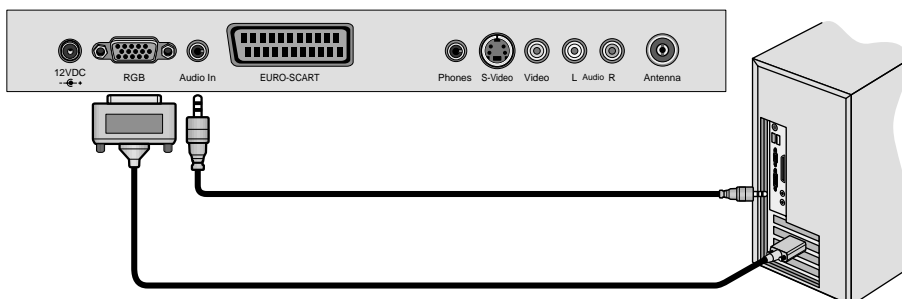

Connecting to the SCART Input

All connections must be made before sealing the front plate into the back box.

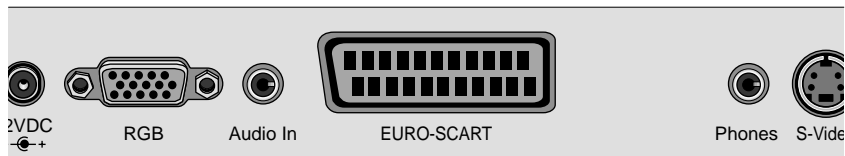

SCART Connection Reference

Pin	Name	Description
1	AOR	Audio Out Right
2	AIR	Audio In Right
3	AOL	Audio Out Left + Mono
4	AGND	Audio Ground
5	BGND	RGB Blue Ground
6	AIL	Audio In Left + Mono
7	B	RGB Blue
8	SWTCH	Audio, RGB switch, 16:9
9	GGND	RGB Green Ground
10	CLKOUT	Clock Out
11	G	RGB Green
12	DATA	Data Out
13	RGND	RGB Red Ground
14	DATAGND	Data Ground
15	R	RGB Red
16	BLNK	Blanking Signal
17	VGND	Composite Video Ground
18	BLNKGND	Blanking Signal Ground
19	VOUT	Composite Video Out
20	VIN	Composite Video In
21	SHIELD	Chassis Ground, Cable Shield

(A) SCART to SCART connector
(RGB Video + Audio L/R or
Composite Video + Audio L/R)

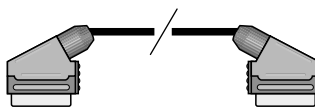

(B) SCART to RCA connectors
(Composite Video + Audio L/R)



(C) SCART to RCA adaptor
(Composite Video + Audio L/R)

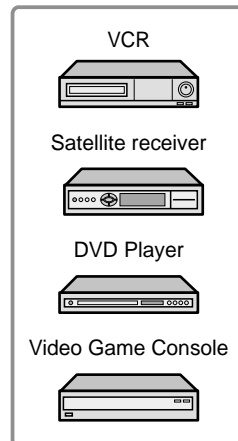

SCART Pinouts
(solder side view)

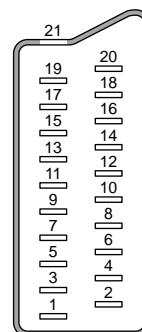

The EURO-SCART socket can be connected to equipment with RGB or composite video inputs and outputs. A VCR, satellite or cable receiver, DVD player, or video game console should be connected using the EURO-SCART connection.

- ◆ The EURO-SCART socket is fully connected as shown above.
- ◆ The audio output from the EURO-SCART can be connected to a separate amplifier to allow integration with a multi room audio video system. This should be carried out by a qualified engineer.
- ◆ Adaptors are commercially available to allow video and audio equipment to be connected to the TileVision® via the EURO-SCART socket. See the examples in diagrams B and C.
- ◆ The 3.5 mm stereo Headphone socket provides a variable volume audio output which can be connected to the auxiliary input of an audio amplifier.
- ◆ If the TileVision® is not being installed in a bathroom an extension lead can be connected to the Headphone socket. The other end of the extension lead should be terminated at a surface mounted socket of the appropriate type.

Installing the Front Plate

Note: A glass carrier/suction lifter is required.

Checking back box prior to installation of front plate

Before commencing the installation of the front plate the polystyrene-blanking panel must be removed from the back box. The next step is to ensure that the appropriate cables and their connectors are present within the back box.

It is important to ensure that the flange inside the back box is cleaned using a grease removal agent and allowing it to dry. The space between the back box and front plate must be even on all 4 sides. If the flange needs to be straightened, this must be done before proceeding any further. This is very important, as any damage will affect the unit's waterproofing capabilities.

Installation of the front plate

Remove the front plate from its packaging and place the remote control to one side, next remove the protective plastic film from the glass.

Introduce the lower front edge of the unit into the box and fit the earth straps to the two Earthing screws as indicated by the green labels on the rear of the front plate. Connect all cables to their respective sockets (refer to pages 6 to 9 of these instructions).

The next step is to remove the soft adhesive protector from the top length of special Velcro, and press the front plate into the back plate (it may be necessary to adjust the position of the cables to achieve a good fit).

The unit installation must comply with all relevant electrical safety regulations before turning the mains supply to the 24VDC power adaptor on using the remote pull switch. The unit should now show a red indicator light showing that it is in standby mode.

The next step is to tune the unit as detailed on pages 14 to 17.

Once you are satisfied that the unit is tuned and working correctly, press the Power 0/I button to put the unit in standby mode and isolate the unit using the remote pull switch.

Gently remove the front plate using a suction lifter; please do not use a lever to remove the front plate as this will invalidate your guarantee. Next, remove the self-adhesive protectors from the side and bottom Velcro strips and press the front panel into the back box with reasonable force. Take care to apply force to all 4 sides of the box. Restore mains power to the unit using the remote pull switch and press the Power 0/I button to turn the unit on again and check that it is still working correctly.

Sealing the unit

When you are sure that the unit is installed correctly put it in standby mode and apply a clear silicone sealant to the joint between the sides of the back box and the sides of the front plate. Ensure that the silicone is worked into the gap evenly and is applied without any gaps, bubbles, etc. Wipe any excess silicone away; check visually for any gaps or bubbles and rectify if necessary. This seal is of the greatest importance to the reliable and safe operation of this unit and must be waterproof.

Sealing Tip: To achieve a neat seal easily it is good practice to use masking tape around the TileVision® glass screen and the surrounding tiles, just leaving sufficient gap to apply the silicone sealant around the joint between the sides of the back box and front plate.

Note: It is the installer's responsibility to ensure that the TileVision® unit is installed and sealed correctly, failure to do so will invalidate your guarantee. The unit will require cleaning and re-sealing after any servicing/repair operation

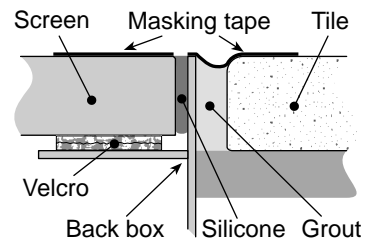

Cleaning Instructions

To clean the front screen, use only a soft damp cloth. Under no circumstances are abrasive cleaners to be used, failure to observe this warning will invalidate your guarantee.

Remote Control

- 1 Power On/Off button**
Turns the TileVision® on or off from standby
- 2 PSM (Picture Status Memory) button**
Recalls the preferred picture setting
- 3 SSM (Sound Status Memory) button**
Recalls the preferred sound setting
- 4 Mute button**
Turns the sound on or off
- 5 Number buttons**
Selects programme numbers
- 6 OK button**
Accepts your selection or displays the current mode
- 7 VOL (Volume) buttons**
Adjust the volume and selects/adjusts Menu Items
- 8 PR (Programme up/down) buttons**
Selects next or previous programme or Menu Item
- 9 Menu button**
Displays the Main Menu
- 10 Teletext On/Off/Mode button**
See page 30 for Teletext function table (buttons 10 to 15)
- 11 Teletext Mix button**
- 12 Teletext Hold button**
- 13 ARC (Aspect Ratio Control) button.** Various picture formats are available: Auto, 16:9,14:9, 4:3, 16:9 zoom, 14:9 zoom, 4:3 zoom. Press the ARC Button repeatedly to select the desired format

Note: only 16:9 and 4:3 are available in PC mode
- 14 Teletext Sub-page and Time button**
Press to display the time when viewing TV programmes
- 15 TV/AV button**
Selects between TV, SCART, S-VIDEO, RADIO (only when enabled) or PC mode. Clears the menu from the screen
- 16 I/II Sound Mode and Red FastText and button**
Selects the language during dual language broadcasts.
Selects the sound output
- 17 Sleep Timer and Green FastText button**
Press to set the sleep timer when viewing TV programmes
- 18 Quick View and Yellow FastText button**
Switches back to the perviously viewed TV programme
- 19 List and Blue FastText button**
Press to display the programme list

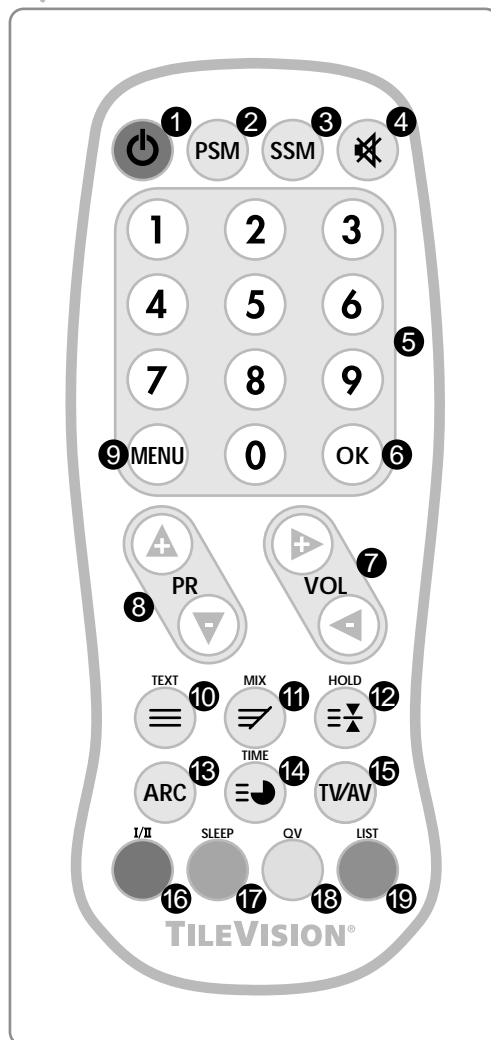



➡ **Make sure there are no objects between the remote control and its sensor.**

Do not place the remote control near a heater.

A strong blow to the remote control may cause it not to operate.

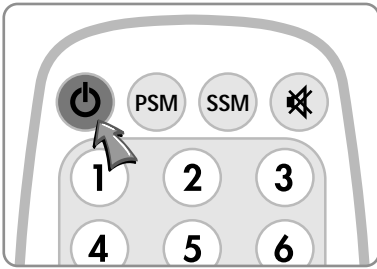
Switching the TileVision® On/Off



- 1 To switch your TileVision® on, press the **POWER** () button.
- 2 To switch your TileVision® off, press the **POWER** () button again.

Selecting a Picture from External Sources

After your various systems (audio and video) have been connected, you can view any of the sources by selecting the appropriate external input.

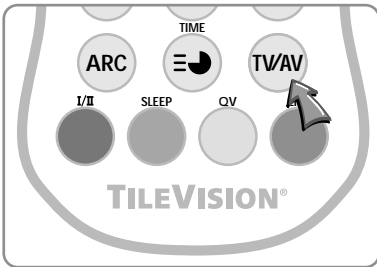

- 1 Make sure all the necessary connections have been made.
- 2 Press the **POWER** () button to switch the device on.
- 3 Press the **TV/AV** button to select required external input mode – Antenna (TV), SCART, S-VIDEO, RADIO (when enabled) or PC mode.
The input is shown at the top right corner of the screen.

Selecting your On-screen Language

When you start using your TV for the first time, you must select the language in which to display all on-screen menus.

Setup

Auto programme ▶
Manual programme ▶▶
Programme edit ▶▶
Language ▶▶

Language

English
Deutsch
Français
Español
Italiano
Nederlands
Português

- 1 Press the **MENU** () button.
- 2 Press the **PR** ▲▼ buttons to select the **Setup** menu and then press the **VOL** ▶ button.
- 3 Press the **PR** ▲▼ buttons to select the **Language** menu and then press the **VOL** ▶ button.
- 4 Press the **PR** ▲▼ buttons to select your desired language and then press the **VOL** ▶ button.
- 5 Press the **TV/AV** button.

All the on-screen displays will now appear in the selected language.

On-screen Menus and Displays

- 1 Press the **MENU** button to display the main menu.
- 2 Press the **PR** ▲▼ buttons to select menus.
- 3 Press **VOL** ◀▶ buttons to adjust menu items.
- 4 Press **MENU** to go back to the previous menu.
- 5 Press **TV/AV** to exit the menus and confirm settings.

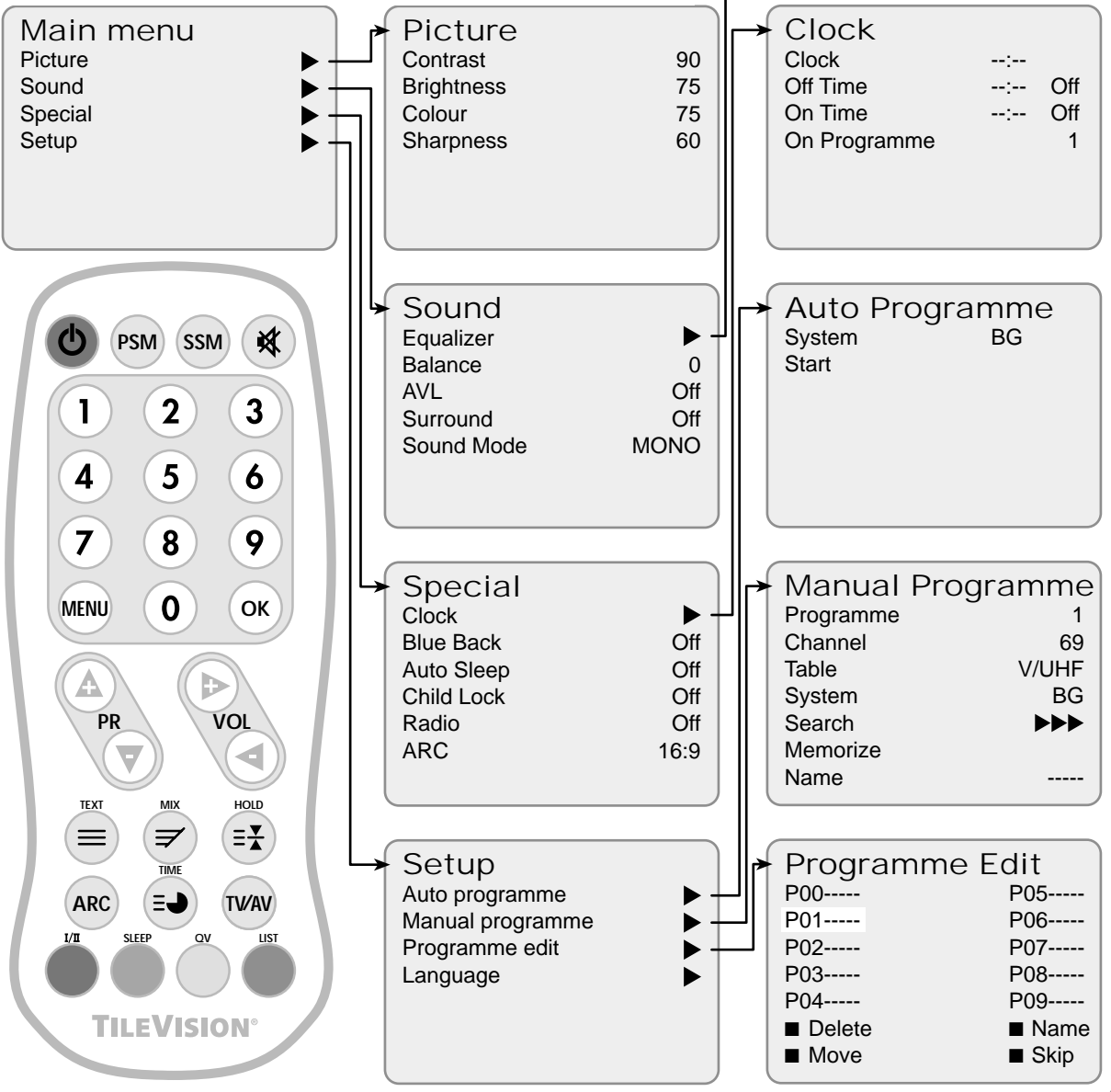

Tuning, Setup and Editing TV Programmes

Note: It is recommended that Auto Programme is used when installing TileVision® as all available programmes will be stored.

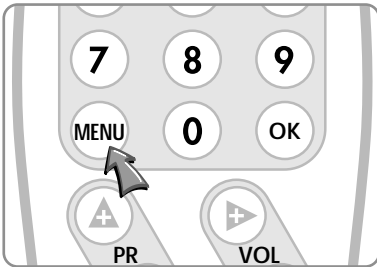

Main menu

Picture ▶
Sound ▶▶
Special ▶▶▶
Setup ▶▶▶

Setup

Auto programme ▶▶
Manual programme ▶▶▶
Programme edit ▶▶▶
Language ▶▶▶

Auto Programme

System BG
Start

Auto Programme

- 1 Press the **MENU** button.
- 2 Press the **PR ▲▼** buttons to select the **SETUP** menu and then press the **VOL ►** button.
- 3 Press the **PR ▲▼** buttons to select the **Auto Programme** menu and then press the **VOL ►** button.
- 4 Press the **PR ▲▼** buttons to select System.
- 5 Select a TV system with the **VOL ◀▶** buttons:
BG: Germany/Asia/M.East/Africa/Australia
I: UK/Hong Kong/South Africa
DK: CIS/China/East Europe
L: France.
- 6 Press the **PR ▲▼** buttons to select Start and press the **VOL ►** button to confirm. The Auto Programme will now start, this will take a few minutes to complete.
- 7 Press the **TV/AV** button to return to normal TV viewing.

To delete, skip, move or name the stored programmes see **Programme Edit**, on page 16.

Tuning, Setup and Editing TV Programmes

Manual Programme

- 1 Press the **MENU** button.
- 2 Press the **PR ▲▼** buttons to select the **SETUP** menu and then press the **VOL ►** button.
- 3 Press the **PR ▲▼** buttons to select the **Manual Programme** menu and then press the **VOL ►** button.
- 4 Select a programme with the **VOL ◀▶** buttons or number buttons.
- 5 Press the **PR ▲▼** buttons to select **Channel** menu.
- 6 Press the **VOL ►** button to select a channel, or enter a channel directly with the number buttons.
- 7 Press the **PR ▲▼** buttons to select the **Table** menu.
- 8 Press the **VOL ►** button to select **V/UHF** or **Cable** as required.
- 9 Select a TV system with the **VOL ◀▶** buttons:
BG: Germany/Asia/M.East/Africa/Australia
I: UK/Hong Kong/South Africa
DK: CIS/China/East Europe
L: France.
- 10 Press the **PR ▲▼** buttons to select Search menu.
When you press the **VOL ◀▶** buttons, the TileVision changes programmes in sequence. You will see all the programmes that the TileVision has memorised. You will not see programmes that were either erased or not memorised.
- 11 Press the **PR ▲▼** buttons to select the Memorize menu.
- 12 Press the **VOL ►** button to store it.
- 13 Press the **Menu** button to return to the previous menu.
- 14 Press the **TV/AV** button to return to normal TV viewing.



Main menu

Picture ▶
Sound ▶▶
Special ▶▶▶
Setup ▶▶▶

Setup

Auto programme ▶
Manual programme ▶▶
Programme edit ▶▶
Language ▶▶

Manual Programme

Programme 1
Channel 69
Table V/UHF
System BG
Search ▶▶▶
Memorize
Name -----

Tuning, Setup and Editing TV Programmes

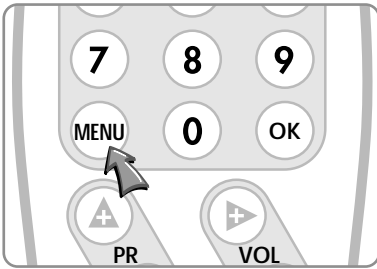

Main menu

- Picture ▶
- Sound ▶▶
- Special ▶▶▶
- Setup ▶▶▶

Setup

- Auto programme ▶
- Manual programme ▶▶
- Programme edit ▶▶▶
- Language ▶▶▶

Programme Edit

- | | |
|----------|---------|
| P00---- | P05---- |
| P01---- | P06---- |
| P02---- | P07---- |
| P03---- | P08---- |
| P04---- | P09---- |
| ■ Delete | ■ Name |
| ■ Move | ■ Skip |

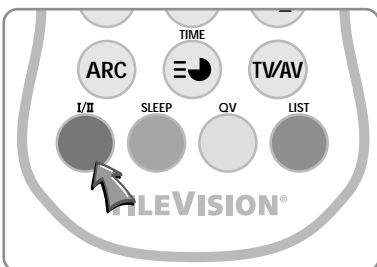

Programme Edit

This function enables you to delete or skip the stored programmes.

You can also move channels to different programme numbers, or insert blank programme data into the selected programme number.

- 1 Press the **MENU** button.
- 2 Press the **PR ▲▼** buttons to select the **SETUP** menu and then press the **VOL ▶** button.
- 3 Press the **PR ▲▼** buttons to select **Programme Edit** and then press the **VOL ▶** button.
- 4 Select the programme name to edit with the **PR ▲▼** buttons and **PR ▲▼** buttons.

Deleting a programme

- 1 Select a programme to be deleted with the **PR ▲▼** or **VOL ◀▶** buttons.
- 2 Press the **RED** button once. The selected programme is deleted, all the following programmes shift up one position.

Tuning, Setup and Editing TV Programmes

Naming a programme in Programme Edit menu

- 1 Select a programme to be named with the **PR ▲▼** or **VOL ◀▶** buttons.
- 2 Press the **GREEN** button.
- 3 Press the **PR ▲▼** buttons repeatedly to select letters (A to z – Capitals and small), numbers (0 to 9), blank or – . Press the **VOL ◀▶** buttons to select the position of the character (1 to 5) in the programme name.
- 4 Press the **OK (OK)** button to store it.
- 5 Press the **MENU** button to return to the previous menu.
- 6 Press the **TV/AV** button to return to normal TV viewing.

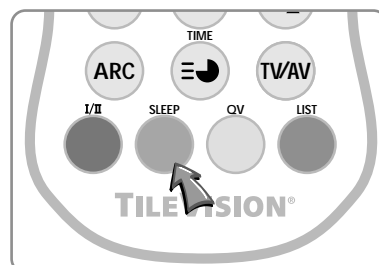

Edit Name

Station P01

▲

▼

Moving a programme in Programme Edit menu

- 1 Select a programme to be moved with the **PR ▲▼** or **VOL ◀▶** buttons.
- 2 Press the **YELLOW** button.
- 3 Move the programme to the desired programme number with the **PR ▲▼** or **VOL ◀▶** buttons.
- 4 Press the **YELLOW** button again to release this function.

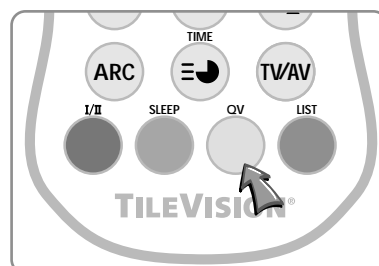

Skipping a programme number in Programme Edit menu

- 1 Select a programme to be skipped with the **PR ▲▼** or **VOL ◀▶** buttons.
- 2 Press the **BLUE** button. The skipped programme turns blue.
- 3 Press the **BLUE** button again to release the skipped programme.

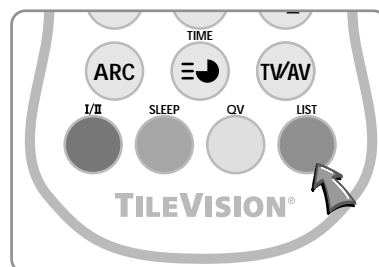

Picture Control

You can adjust picture Contrast, Brightness, Colour and Sharpness to the levels you prefer.

Main menu

Picture ▶
 Sound ▶▶
 Special ▶▶▶
 Setup ▶▶▶

Picture

Contrast 90
 Brightness 75
 Colour 75
 Sharpness 60

Manual Picture Control



- 1 Press the **MENU** button.
- 2 Press the **PR ▲▼** buttons to select the Picture menu and then press the **VOL ▶** button.
- 3 Press the **PR ▲▼** buttons to select a picture item.
- 4 Press the **VOL ◀▶** buttons to adjust the picture setting to your requirement.
- 5 Press the **TV/AV** button to store your personal preferences in **User**.

Selected Item	Setting Change
Contrast	Less Contrast VOL ◀ 0–100 ▶ VOL More Contrast
Brightness	Darker VOL ◀ 0–100 ▶ VOL Brighter
Colour	Lower Colour Intensity VOL ◀ 0–100 ▶ VOL Higher Colour Intensity
Sharpness	Soft picture VOL ◀ 0–100 ▶ VOL Sharp Picture

Auto Picture Control

The Picture options – Dynamic, Standard, Mild, and Game are programmed for optimum picture reproduction at the factory and cannot be changed.

PSM (Picture Status Memory)

- 1 Press the PSM () button.
- 2 Press the  button repeatedly. Each press of the button changes the screen display as below:

Dynamic → Standard → Mild → Game → User
 ↑

- Dynamic: Vivid Picture.
- Standard: Standard Picture.
- Mild: Softer Picture.
- Game: External Video Game Picture Setup.
- User: Manual Picture Setup.

- 3 Press the () button.



 In PC mode, the PSM function is not available.

Sound Control

Preferred sound setting can be selected; Flat, Music, Movie or Speech.

Manual Sound Control

The **Equalizer** can be manually adjusted by cutting and boosting the five selected frequency bands and storing the settings as **User**.

The left to right **Balance** can be adjusted and if **AVL** is switched on there will be a more equal volume level between programmes.

- 1 Press the **MENU** button.
- 2 Press the **PR** ▲▼ buttons to select the **Sound** menu, and then press the **VOL** ► button.
- 3 Press the **PR** ▲▼ buttons to select the desired menu item: **Equalizer**, **Balance**, **AVL** (Automatic Volume Leveller), **Surround**, or **Sound Mode**, then press the **VOL** ► button.
- 4 Press the **VOL** ◀► buttons to make desired adjustment.
- 5 Press the **VOL** ► buttons in **Equalizer** to set the Equalizer.
- 6 Press the **PR** ▲▼ buttons to select the preferred setting: **Flat**, **Music**, **Movie**, **Speech**, or **User**. To set the **Equalizer User**:
 - a) Select **User** by pressing the **PR** ▲▼ buttons.
 - b) Select a sound band by pressing the **VOL** ◀► buttons.
 - c) Make the desired sound level adjustment with the **PR** ▲▼ buttons.
 - d) Press the **MENU** button to return to the preceding menu, and the **TV/AV** button to return to normal TV viewing.
- 7 Press the **PR** ▲▼ buttons to select **Balance** and adjust the left to right balance with the **VOL** ◀► buttons.
- 8 Select **AVL** with the **PR** ▲▼ buttons and use the **VOL** ◀► buttons to select **ON** or **OFF**.
- 9 Select **Surround** with the **PR** ▲▼ buttons and use the **VOL** ◀► buttons to select **ON** or **OFF**.
- 11 Select **Sound Mode** with the **PR** ▲▼ buttons and use the **VOL** ◀► buttons to select **MONO** or **STEREO**. Selecting mono may improve the sound quality of poor broadcasts.

If a programme is received in two languages (dual language), you can switch to **DUAL I** or **DUAL II** by pressing the **VOL** ► button.

DUAL I – sends the primary broadcast language to the loudspeakers. **DUAL II** – sends the secondary broadcast language to the loudspeakers.

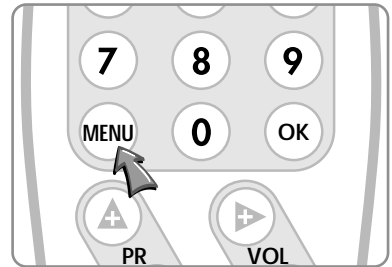

Main menu

Picture	▶
Sound	▶▶
Special	▶▶▶
Setup	▶▶▶▶

Sound

Equalizer	▶
Balance	0
AVL	Off
Surround	Off
Sound Mode	MONO

Equalizer

Flat	
Music	
Movie	
Speech	
User	

0.1 0.5 1.5 5.0 10KHz

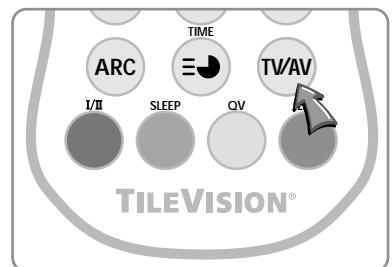

Sound Control



Auto Sound Control

The sound settings for **Flat**, **Music**, **Movie**, and **Speech** are programmed at the factory for optimum sound reproduction, and cannot be changed.

SSM (Sound Status Memory)

1 Press the **SSM** (SSM) button.

2 Press the SSM button repeatedly to select.

Each press of the button changes the screen display as below.

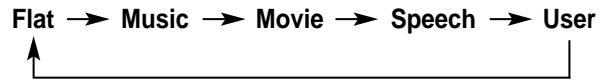







3 Press the OK button.

PC Picture Adjustment

PC/DTV Input

- 1 Connect the PC IN cable (D-Sub) from the monitor output socket of the PC to the PC ANALOG input socket of the TileVision.
- 2 Connect the PC Audio IN cable from the PC to the PC AUDIO IN of the TileVision.
- 3 Press the **TV/AV** () mode.
- 4 Switch on the PC, and the PC screen appears on the TileVision.

Picture Adjustment

- 1 Press the **TV/AV** button to select the PC Mode.
- 2 Press the **MENU** button.
- 3 Select the **Picture** function with the **PR**   buttons and then press the **VOL**  button.
- 4 Press the **PR**   buttons to select the desired picture item.
- 5 Press the **VOL**   buttons to make appropriate adjustments.
- 6 Press the **TV/AV** button to exit the menu.



The **Auto** function is for the automatic adjustment of the screen position, clock and clock phase. The displayed image will disappear for a few seconds while the auto configuration is in process.

Reset returns the picture settings to those programmed at the factory and cannot be changed.

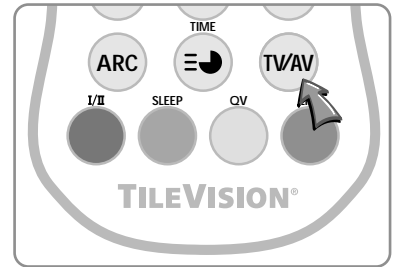
 **Signals from some graphics boards may not function properly. If the results are unsatisfactory, adjust clock and clock phase manually.**



Menu

Picture 
Sound 
H/V Position 
Auto
Reset

1024 x 768 60Hz

Picture

Contrast	60
Brightness	80
Colour	9300K
Clock	50
Phase	34
ARC	16:9

PC Picture Adjustment

Contrast – adjusts the balance between light and dark areas of the picture.

Brightness – makes the picture darker or brighter as preferred.

Temperature – adjusts the 'warmth' of the image colour (colour temperature).

Clock – allows adjustment to minimise any vertical bars or stripes visible on the screen background. The horizontal screen size will also change.

Phase – allows the removal of any horizontal noise. The images of characters can also be sharpened.

ARC (Aspect Ratio Control) – Selects a screen mode. 4:3 or 16:9

Mode	Resolution	Horizontal Frequency (KHz)	Vertical Frequency (Hz)
VGA	640 x 480	37.9	72
	640 x 480	37.5	75
	720 x 400	31.4	70
SVGA	800 x 600	35.1	56
	800 x 600	37.9	60
	800 x 600	48.1	72
	800 x 600	46.9	75
XGA	1024 x 768	48.4	60
	1024 x 768	56.5	70
	1024 x 768	60.0	75
WXGA	1280 x 768	47.4	60HzRB
	1280 x 768	47.8	60
DTV	720 x 480p	31.5	60
	720 x 576p	31.2	50
	1280 x 720p	45.0	60
	1280 x 720p	37.5	50
	1920 x 1080i	33.7	60
	1920 x 1080i	28.1	50

✎ Signals from some graphics cards may not lock properly. If the results are unsatisfactory, adjust the clock and clock phase manually.

If the set is cold, there may be a small 'flicker' when first switched on. This is normal, there is nothing wrong with the equipment.

Some red, green and blue dot effects may appear. This is caused by aliasing and has no impact on the equipment.

H/V Position

H-Position	50
V-Position	50

✎ When the screen size is 4:3 mode, H-Position is not available.

Position Adjustment

This function allows the user to adjust the picture left/right or up/down as required.

- 1 Press the **MENU** button.
- 2 Select the **H/V Position** menu with the **PR ▲▼** buttons and then the press the **VOL ►** button.
- 3 Press the **PR ▲▼** buttons to select the desired position item.
- 4 Press the **VOL ◀▶** button to adjust horizontal position and vertical position.
- 5 Press the **TV/AV** button to exit menu.

PC Sound Adjustment

- 1 Press the **TV/AV** button to select PC mode.
- 2 Press the **MENU** button.
- 3 Select the Sound function with the **PR ▲▼** buttons and then press the **VOL ►** button.
- 4 Press the **PR ▲▼** buttons to select the desired sound item: **Equalizer, Balance, AVL, Surround** or **Sound Mode**.
- 5 Press **VOL ◀▶** buttons to make desired adjustment.
- 6 Press **VOL ◀▶** buttons in Equalizer to set the Equalizer.
- 7 Press the **PR ▲▼** buttons to select your preferred setting: **Flat, Music, Speech** or **User**.
To set the Equalizer User –
 - a) Select User by pressing the **PR ▲▼** buttons.
 - b) Select a sound band by pressing the **PR ▲▼** buttons.
 - c) Make appropriate sound level with the **PR ▲▼** buttons.
 - d) Press the Menu button to return to the proceeding menu.
- 8 Press the **PR ▲▼** buttons to select the Balance menu.
- 9 Select the **Balance** menu with the **VOL ◀▶** buttons and adjust the balance of the speakers.
- 10 Select the **AVL** (Automatic Volume Leveller) menu ON or OFF.
- 11 Select the Surround menu ON or OFF.
- 12 Select the Sound Mode with the **PR ▲▼** buttons.
- 13 Press the **VOL ◀▶** buttons to select modes – L+R, L+L, R+R.
L+R: The audio L input signal is sent to the left loudspeaker and the audio R input signal is sent to right loudspeaker.
L+L: The audio L input signal is sent to both loudspeakers.
R+R: The audio R input signal is sent to both loudspeakers.
- 14 Select the Input with **PR ▲▼** buttons. (Input only appears in the menu if the Radio function in on – see page 25.)
- 15 Press the **VOL ◀▶** buttons to select sound input, either PC or Radio.

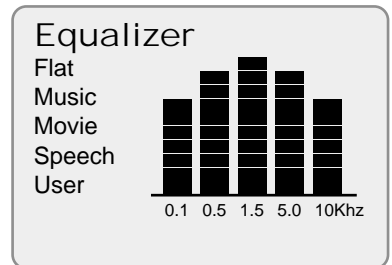
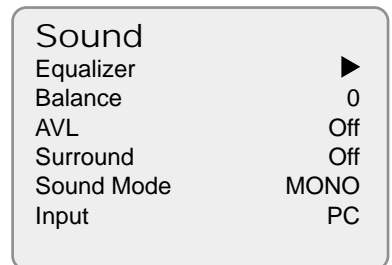
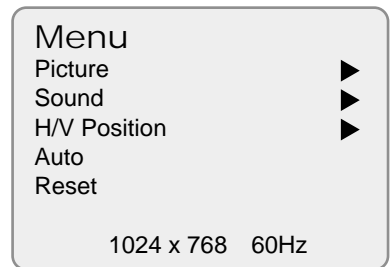
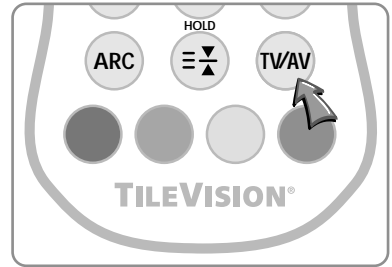

👉 When selecting the radio mode, sound mode switches between **MONO** and **STEREO** according to the received signal.

Clock

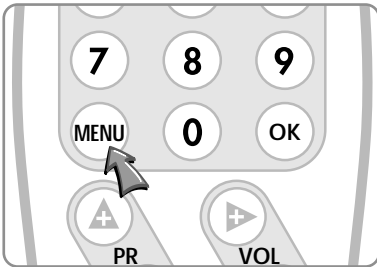

Special

Clock	▶
Blue Back	Off
Auto Sleep	Off
Child Lock	Off
Radio	Off
ARC	16:9

Clock

Clock	--:--	
Off Time	--:--	Off
On Time	--:--	Off
On Programme		1

Setting the clock is necessary in order to use the various timer features of the TileVision. You can set automatic TV On or Off time.

- 1 Press the **MENU** button.
- 2 Press the **PR ▲▼** buttons to select the **Special** menu, press the **VOL ▶** button.
- 3 Press the **VOL ◀▶** buttons to select the Clock menu.
- 4 Press the **VOL ▶** button to enter the --:-- field and set the present time with the **PR ▲▼** buttons. Store a time value between 00:00 and 23:59 (hours: minutes).
- 5 Press the **PR ▲▼** buttons to select **Off Time**.
- 6 Press the **VOL ▶** button to enter the --:-- field and set the **TV off time** with the **PR ▲▼** buttons. Select **On** or **Off** with the **PR ▲▼** buttons.
- 7 Press the **VOL ▶** button to enter the --:-- field and press the **PR ▲▼** buttons to select **On Time**.
- 8 Press the **VOL ▶** button to enter the --:-- field and set the **TV on time** with the **PR ▲▼** buttons. Select **On** or **Off** with the **PR ▲▼** buttons. When the setting is **On**, the TileVision will be switched on automatically to the last selected programme.
- 9 Press the **PR ▲▼** buttons to select the **On Programme**. You can select the first displayed programme when the set is switched on automatically with the **VOL ◀▶** buttons.
- 10 Press the **TV/AV** () button to return to normal TV viewing.

Blue Back

Special



Clock	▶
Blue Back	Off
Auto Sleep	Off
Child Lock	Off
Radio	Off
ARC	16:9

If no signal is being received or the signal is very weak, a blue screen automatically replaces the noisy picture background.

- 1 Press the **MENU** () button.
- 2 Press the **PR ▲▼** buttons to select the **Special** menu, and then press the **VOL ▶** button.
- 3 Press the **PR ▲▼** buttons to select **Blue Back**.
- 4 Press the **VOL ◀▶** buttons to select **On** or **Off** as required.

Auto Sleep

If you select **Auto Sleep On** the TileVision® will automatically switch itself to standby mode approximately ten minutes after the TV channel stops broadcasting.

- 1 Press the **MENU** () button.
- 2 Press the **PR** ▲▼ buttons to select the **Special** menu, and then press the **VOL** ► button.
- 3 Press the **PR** ▲▼ buttons to select **Auto Sleep**.
- 4 Press the **VOL** ◀▶ buttons to select **On** or **Off**.
- 5 Press the **TV/AV** () button to return to the normal TV viewing.

Special

Clock	►
Blue Back	Off
Auto Sleep	Off
Child Lock	Off
Radio	Off
ARC	16:9

Child Lock

This function is not applicable to TileVision.

Radio

You can listen to FM radio if the antenna is connected to the TileVision via the ANT socket. Before tuning into radio programmes the **Radio On** selection must be made in the **Special** menu.

- 1 Press the **MENU** () button.
- 2 Press the **PR** ▲▼ buttons to select the **Special** menu, press the **VOL** ► button.
- 3 Press the **PR** ▲▼ buttons to select the **Radio**.
- 4 Press the **VOL** ◀▶ buttons to select **Radio On** or **Off**.

When Radio On is selected in the Special menu Radio Mode can be accessed by using the TV/AV button.

Main menu

Picture	►
Sound	►
Special	►
Setup	►

Special

Clock	►
Blue Back	Off
Auto Sleep	Off
Child Lock	Off
Radio	Off
ARC	16:9

ARC (Aspect Ratio Control)

Special

Clock	▶
Blue Back	Off
Auto Sleep	Off
Child Lock	Off
Radio	Off
ARC	16:9

TileVision can be viewed in various picture formats by repeatedly pressing the **ARC** () button until the desired image is selected.

Auto	16:9	14:9	4:3
16:9 Zoom	14:9 Zoom	4:3 Zoom	

Note: in Zoom mode, you can adjust the position of the picture with the **PR** ▲▼ buttons.

How ARC settings alter the picture

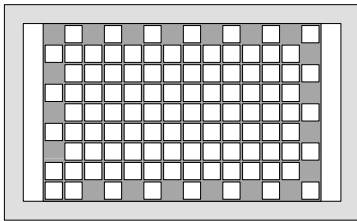

14:9

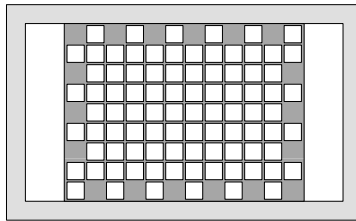

4:3

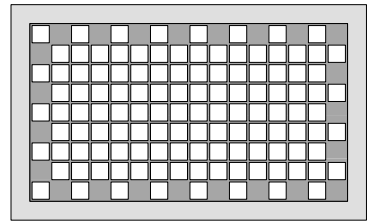

16:9

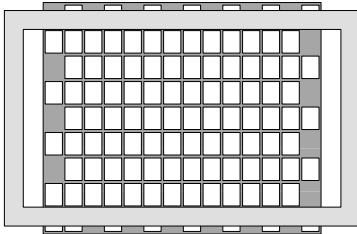

14:9 zoom

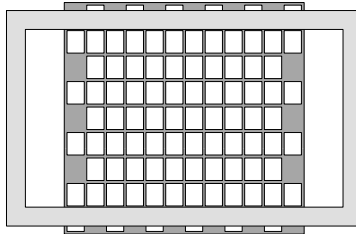

4:3 zoom

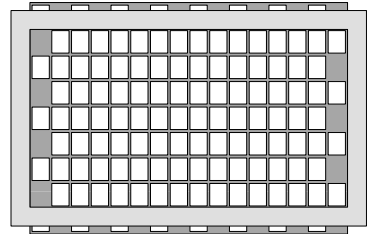

16:9 zoom

Radio Tuning and Setup

Radio Mode can only be accessed by using the TV/AV button after Radio On has been selected in the Special menu.

- 1 Use the **TV/AV** button to select Radio Mode.
- 2 Press the **MENU** button to set Radio Setup menu.
- 3 Press the **VOL** ◀▶ button repeatedly to select the Mode Auto or Manual.
 - When the Radio Setup Mode is Auto, only the programmes stored in memory are selected.
 - When the Radio Setup Mode is Manual, all frequencies are selected.
- 4 Press the **PR** ▲▼ button to select Frequency.

Then press the **VOL** ▶ button repeatedly to tune in the desired station manually. If you press the **VOL** ▶ button continuously for more than 2 seconds it automatically changes present frequency into next frequency.
- 5 Press the **PR** ▲▼ buttons to select Programme.

Then press **VOL** ▶ button repeatedly to select the Programme.
- 6 Press the **PR** ▲▼ buttons to select **Memorize**. If you want to memorise this Radio Setup, press the **VOL** ▶ button.
- 7 Press the **PR** ▲▼ buttons to select **Delete**. Select **Off** with the **VOL** ▶ button to delete the station.
- 8 Press the **PR** ▲▼ buttons to select **Auto Programme**.
- 9 Press the **VOL** ▶ button repeatedly to automatically scan and tune to the next available station.
- 10 Press the **PR** ▲▼ buttons to select **Off Time**. Then press the **VOL** ▶ button repeatedly to select **Off, 5, 10, 30** (minutes). The on-screen displays disappear after time selected (when you select Off, the on-screen displays will not disappear).

The displays identify the status of radio settings.

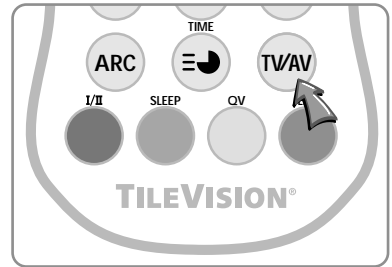

Radio Setup

Mode	Auto
Frequency	87.50 MHz
Programme	1
Memorize	
Delete	
Auto Programme	▶
Off Time	Off
Edit Name	▶
Name	-----

Radio Auto Programme Start

Radio Tuning and Setup

Radio Setup

Station P01 -----
▲
▼

11 Press the **PR ▲▼** buttons to select **Edit Name**.

Then press the **VOL ►** button to edit radio station name.

12 You can assign a radio name with 8 characters.

Press the **PR ▲▼** button repeatedly. You can use numbers 0–9, or letters A–z (capitals and small), and a blank. Press the **VOL ◀▶** buttons to select the position of the character (1 to 5) in the programme name.

13 Press the **MENU (MENU)** button to return to the previous menu.

14 Press the **TV/AV (TV/AV)** button to exit. Then the radio setting condition is displayed.

Calling the Programme List

Programmes stored in the memory can be checked by displaying the programme LIST.

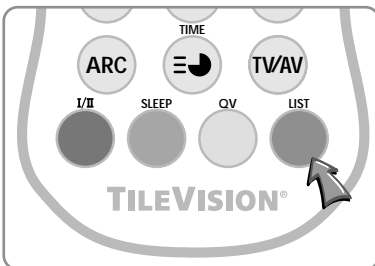

Programme Edit

P00----	P05----
P01----	P06----
P02----	P07----
P03----	P08----
P04----	P09----

Displaying Programme List

Press the **LIST** button to display the programme list menu.

The programme list appears on the screen. Each programme list contains ten programmes.

Selecting a programme in the programme list

Select a programme with the **PR ▲▼** or **VOL ◀▶** buttons. Then press the **OK** button. The set switches to the chosen programme.

Paging through the programme list

There are 10 programme table pages giving a total of 100 programmes. Pressing the **PR ▲▼** or **VOL ◀▶** buttons repeatedly turns the pages.

 Programmes shown as blue have been set up to be skipped by auto programme or manually in the programme edit mode.

Any programmes with the channel number shown in the programme list indicate there is no station name assigned.

Teletext

Functions of Teletext

Part Display Contents

- A Selected page number.
- B Broadcast Station identity.
- C Current page number or searching status.
- D Date and time.
- E Text information.
- F FasText information.
Red, Green, Yellow, Blue

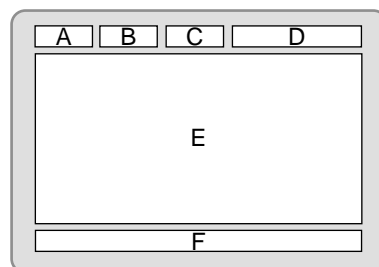

Displaying the Teletext Information

- 1 Press the **TEXT** (≡) button once to display the Teletext pages.
- 2 Press the **MIX** (≡) button to display the Teletext pages superimposed on the TV picture.
- 3 Press the **TEXT** button once more to display the Teletext pages and TV picture together.
- 4 Press the **TEXT** button again to switch Teletext off and return to TV mode.

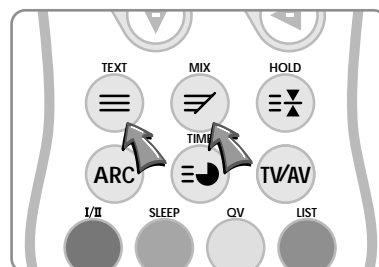

Teletext Button Functions

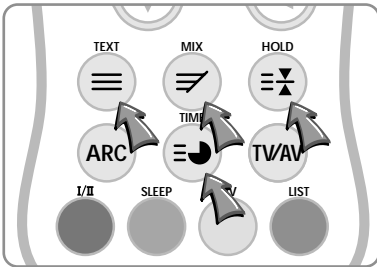

The table below gives a complete explanation of each of the Teletext buttons.

Button	Menu	Functions
	TEXT	Changes Teletext mode – press button for text mode, text and TV picture side by side, return to TV mode.
	MIX	In Teletext mode – press button to superimpose the text page over the TV picture
	HOLD	Stops the automatic page change, which occurs if a Teletext page consists of two or more sub pages. Stop symbol is displayed in the top left hand corner of the screen. Press the button again to resume.
	TIME	When viewing a TV programme, press this button to display the time at the top right hand corner of the screen. Press the button again to remove the display. In Teletext mode press this button to select and hold or change a four digit sub page number. This is displayed along the bottom of the screen. Press the button again to exit this function.
	SIZE	Selects double height text. Press button to enlarge top half of the page. Press again to enlarge the bottom half of the page. Press again to return to normal size text.
	INDEX	Return to the index page.
	UPDATE	Displays the TV picture on the screen while waiting for the new Teletext page. The display will appear at the top left hand corner of the screen. When the updated page is available then the display will change to the page number. Press the UPDATE button to view the updated Teletext page.
	REVEAL	Press this button to display concealed text, such as answers to quiz games. Press the button again to remove the information from the display.

The first four Teletext functions are available on the waterproof remote control. The full function remote control must be used to access the Index, Update and Reveal functions.

Troubleshooting

No picture or sound.

- ✎ Make sure the AC power cord is connected to the 12V power adapter.
- ✎ Make sure the 12V DC power cord is connected to the TileVision®.
- ✎ Check for power failure.
- ✎ If the red indicator is not showing press the POWER () button on the remote control

Screen is black.

- ✎ Make sure the external signal source mode is selected.
- ✎ Press the signal input button **TV/AV** () to change to TV.

Picture is OK but there is no sound.

- ✎ Press the **Mute** () button.
- ✎ Check another channel.
- ✎ Press the button to increase the volume.
- ✎ Check the speaker connections from the TileVision® to the speakers.

Poor sound quality.

- ✎ Make sure the channel is broadcasting in stereo.
Press the **I/II** button to Select Mono. The sound quality of a stereo broadcast may be poor in a weak signal area.
(See page 19)

No image on a specific channel.

- ✎ Make sure the channel selection is correct.
- ✎ Change the antenna direction to the right or left.
- ✎ Adjust the fine tuning of the channel.

Image is not stable and may appear to vibrate, horizontal bars appear.

- ✎ Adjust the fine tuning of the channel.
- ✎ Make sure there is no powerful electromagnetic wave interference from the transmitting station.
- ✎ Stop using a hair drier, electric drill or electric blender.

No colour on a specific channel (a black & white image).

- ✎ Check other channels to see if the specific channel is broadcasting a black & white program.
- ✎ Adjust the colour. (See page 18)

Black or white dots appear on all channels or a specific channel.

- ✎ Make sure the antenna is connected correctly. (See page 7)
 - ✎ Make sure the status of the antenna or wire is good.
 - ✎ Adjust the fine tuning of the channel.
-

Specifications – TV/17/FR3/PS

Model		TV/17/FR3/PS
External Dimensions	(W x H x D)	483 mm x 353 mm x 75 mm
Total Weight		12 Kg complete with backbox
Power	Requirements	12 VDC/5.0 A
	Consumption	50 W max, standby below 3 W
	AC/DC Power Adaptor	Input 100–240 VAC 50/60 Hz
		Output 12 VDC/5.0 A
System		PAL-BG, I, DK / SECAM-BG, DK, L / AV NTSC
TV	Programme	VHF:2–12 UHF 21–69 Cable S1–S41 FVS 100 programme
LCD	Size	17" (434 mm) Diagonal – Widescreen
	Resolution/Pixel no.	WXGA (1280 x 768)
	Type	a-si TFT active matrix
	Brightness	450 cd/m ²
	Contrast Ratio	800:1
	Viewing Angle	L/R/U/D 85°/85°/85°/85°
	Colour Depth	16.2 M colours
Response Time		15 ms (Typ)
External Antenna Impedence		VHF/UHF at 75 Ohm
Audio Output		2.5 W + 2.5 W rms (both channels driven) Nicam, A2 Stereo Graphic Equaliser
OSD		Programme list/edit Menu – multi language – halftone
Connection Ports	Input	12 VDC/5.0 A
		PC AUDIO
		PC ANALOG (D-SUB)
		FULL EURO-SCART (RGB,FB,AV-IN/OUT)
		S-VIDEO
	ANTENNA/TUNER (Co-axial)	
Output		Headphones (3.5 mm stereo jack) Speakers (clip terminals)
Supplied Loudspeakers		External, Waterproof, 4Ω
Functions		CATV/Hyper band Auto Programme Manual Programme Auto Sleep Quick View ACMS (Auto Channel Memory System) PSM (Picture Status Memory) SSM (Sound Status Memory) AVL (Auto Volume Leveller) ARC (Aspect Ratio Control) FM Radio Teletext – TOP/FLOF – double window Real Clock (On/Off Time)

✎ Design and specifications are subject to change without notice.



PORTER LANCASTRIAN LIMITED
www.tilevision.tv