

TILEVISION® LRC



**Universal
Splashproof
Learning
Remote
Control**

TileVision® Universal Splashproof Learning Remote Control

The remote control is designed to allow the user to control up to three different devices by using the TV, SAT and DVD buttons to select which device is to be controlled.

The remote control is preprogrammed with a library of codes covering all major device brands. The full code lists for televisions, satellite receivers, DVD recorders/players and CBLs are available for download from the www.tilevision.tv web site.

The remote control also has the facility to directly learn remote control codes from other infrared remote controls. This allows the remote control to learn up to 41 functions for each chosen device.

The remote control can be used in replace of the Sky™ satellite receiver remote control. Enabling control of both the Sky™ satellite receiver and the TileVision from a single remote control.

Contents

| | <i>Page</i> |
|---|-------------|
| The Remote Control | 1 |
| Activating the Remote Control | 2 |
| Replacing the Battery | 2 |
| How to Control a Device | 3 |
| TileVision® Codes | 3 |
| Entering a Brand Code | 3 |
| Auto Search – All Brand Codes | 4 |
| Manual Search – All Brand Codes | 4 |
| Checking/Recalling a Device Code | 5 |
| Entering a Sky™ Satellite Receiver Code | 5 |
| Manual Programming and Program Deletion | 6 |
| Deleting All Button Programs for One Device | 6 |
| Troubleshooting | 7 |
| Button Assignment Table | 9 |

The Remote Control

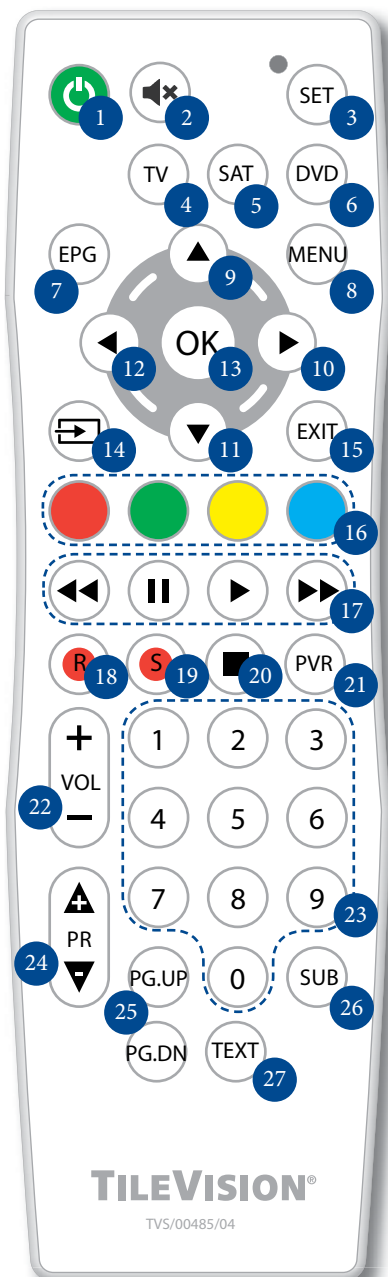

- 1 **Power On/Off button** – Turns the TileVision® on from, or off to, standby
- 2 **Sound Mute button** – Turns the sound on or off
- 3 **SET button** – for manual programming.
- 4 **TV 'Device' button** – Selects the TV's set of button functions
- 5 **SAT 'Device' button** – Selects the Satellite Receiver's set of button functions
- 6 **DVD 'Device' button** – Selects the DVD Player/Recorder's set of button functions
- 7 **EPG button** – Displays the Electronic Programme Guide
- 8 **MENU button** – displays or closes menus
- 9 **Up button** – Menu/EPG navigation
- 10 **Right button** – Menu/EPG navigation
- 11 **Down button** – Menu/EPG navigation
- 12 **Left button** – Menu and EPG navigation
- 13 **OK button** – Accepts menu selections
- 14 **Input Source button** – Displays the Input Source menu and allows source selection
- 15 **EXIT button** – Closes all on-screen menus and lists
- 16 **Colour and Teletext buttons** – DTV Text and text menu options
- 17 **Rewind, Pause, Play, and Fast Forward buttons** – For use with TV Sky+™, Virgin V+, DVDs, VCRs, etc.
- 18 **Record button** – For use with TV Sky+™, Virgin V+, DVDs, VCRs, etc
- 19 **Time Shift Record button**
- 20 **Stop button** – For use with TV Sky+™, Virgin V+, DVDs, VCRs, etc
- 21 **PVR button**
- 22 **VOL Volume up/down buttons** – Adjust the volume
- 23 **Number entry buttons**
- 24 **PR Programme up/down buttons** – Selects next or previous programme
- 25 **Page up/down buttons** – EPG navigation
- 26 **Sub button** – Turns the subtitles on or off
- 27 **TEXT button** – Enters or exits teletext

The TV functions above are the defaults for a new remote control which has not been programmed.

Activating the Remote Control

Before the remote control can be used an insulating plastic film must be removed from beneath the battery.

Place the remote control face down on a horizontal flat surface and use the opener to release the battery compartment cover by rotating it in an anti-clockwise direction. Set the battery cover and opener to one side.

Rest one finger lightly on the battery and pull the printed tag to ease the insulating film from underneath the battery. Try to avoid touching the black O-ring as it is coated with light grease.

Replace the battery cover and lock it back in place using the opener.

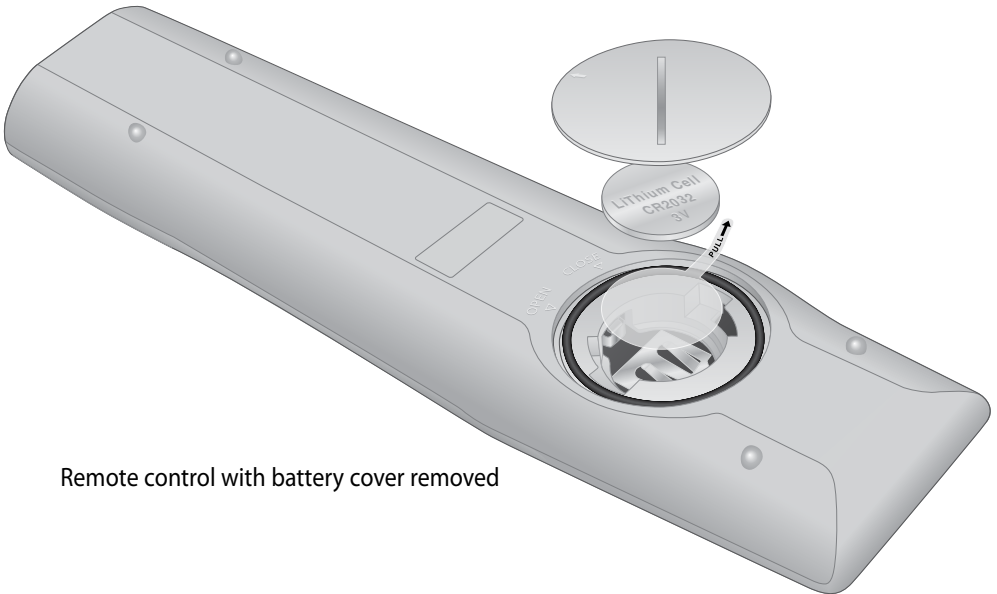

Remote control with battery cover removed

Replacing the Battery

Place the remote control face down on a horizontal flat surface and use the opener to release the battery compartment cover by rotating it in an anti-clockwise direction. Set the battery cover and opener to one side.

Carefully remove the old battery and dispose of it safely.

Try to avoid touching the black O-ring as it is coated in light grease.

Insert the new CR2032 battery with the positive (+) side upwards. Replace the battery cover and lock it back in place using the opener.

How to Control a Device

Press and release the device button: TileVision® (TV), satellite receiver (SAT) or DVD recorder/player (DVD) that you wish to control. Press the function button you require. The LEDs will light to confirm that a signal is being sent and which device is being controlled.

To select a different device to control, press and release the device button: TileVision® (TV), satellite receiver (SAT) or DVD recorder/player (DVD) that you wish to control. Press the function button you require. The LEDs will light to confirm that a signal is being sent and which device is being controlled.

TileVision® Codes

The TileVision® learning remote control is supplied with the TV device button set to the TileVision® TV22/FR1 and TV26/FR2 model remote control codes. If these remote control codes are accidentally erased, or if an alternative TileVision® model's remote control codes are required, enter the appropriate three digit code for the TileVision® model as shown below.

| TileVision® Model | Three Digit Code |
|------------------------------|------------------|
| TV22/FR1, TV26/FR2 | 368 |
| TV19/FR1, TV26/FR1 | 371 |
| TV17/FR5, TV23/FR3 | 369 |
| TV17/FR4, TV17/FR3, TV17/FR2 | 370 |
| TV23/FR2, TV23/FR1 | 370 |

For button assignment information see the table on page 9.

Entering a Brand Code

- 1 Locate the three digit code in the brand list, for the satellite receiver or DVD recorder/player that you wish to control.
- 2 Press and hold down the Television (TV), satellite (SAT) or DVD (DVD) device button until the red light stays on, then release the device button.
- 3 Enter the three digit code using the number buttons 0–9.
- 4 As each digit is entered the red light will flash once and then remain on.
- 5 If the three digit code is correct the red light will go out. If the three digit code is incorrect the red light will flash twice and then remain on.
- 6 Press the original device button again to exit the code entry mode.

Note: If a three digit code is not entered within 30 seconds the red light will flash twice and exit code entry mode. Entering a three digit code will delete/erase the programmed buttons for that device.

Auto Search – All Brand Codes

- 1 Switch the chosen device (TV, satellite receiver, DVD recorder/player) that you wish to find the code for, to **ON**. When the correct code has been found the device will switch **OFF**.
- 2 Press and hold down the TV (TV), satellite (SAT) or DVD (DVD) button until the red light stays on, then release the button.
- 3 Press the power button (⏻) once and release, this will start the auto search mode.
- 4 When the device switches **OFF**. Immediately press and release the device button that was initially selected, to save the code in the remote control.

When the red light switches off, all the codes have been tried and the auto search mode has been exited.

To exit the auto search mode before all the codes have been tried, press and release the device button that was initially selected.

To learn which three digit code has been set to control the device see *Checking/Recalling the Device Code* on page 5.

Manual Search – All Brand Codes

- 1 Switch the chosen device (TV, satellite receiver, DVD recorder/player) that you wish to find the **code** for, to **ON**. When the correct code has been found the device will switch **OFF**.
- 2 Press and hold down the TV (TV), satellite (SAT) or DVD (DVD) button until the red light stays on, then release the button.
- 3 Press PR+ (+) or PR- (-) once and release. Each time PR+ (+) or PR- (-) is pressed a code is transmitted.

To perform a fast search, press and hold down PR+ (+) or PR- (-) button.

When the device switches **OFF**, release the PR+ (+) or PR- (-) button.





Step 4 must be executed so that the code is saved in the remote control.

- 4 Press and release the device button that was initially selected to save the code in the remote control.

To learn which three digit code has been set to control the device see *Checking/Recalling the Device Code* on page 5.

Checking/Recalling a Device Code

To find out which three digit code is controlling any device:

- 1 Press and release the device button: TV () , satellite () or DVD () for which you want to find the code.
- 2 Press the same device button again, together with the OK () button and release both buttons.
- 3 The red light will flash.
- 4 Count the number of flashes for each digit in the three digit code.
- 5 The red light will remain off for a short time between numbers.
- 6 When all three numbers have been flashed the red light will remain off.

One Flash = 1

Two Flashes = 2

Three Flashes = 3

Four Flashes = 4

Five Flashes = 5

Six Flashes = 6

Seven Flashes = 7



Eight Flashes = 8

Nine Flashes = 9

Ten Flashes = 0

For example:

Press and release the DVD () button.

Press and release the DVD () and OK () buttons.

The remote control would then show nine flashes (9), pause, two flashes (2), pause, and one flash (1), to confirm the three digit code of 921.

Entering a Sky™ Satellite Receiver Code

Refer to page 3 - Entering a Brand Code.

Press and hold down the satellite () device button until the red light stays on, then release the device button.

Enter the 3 digit code. 192, 288 to 294 inclusive.





Test the functionality of the control of the Sky™ satellite receiver.

Manual Programming and Program Deletion

High levels of ambient light such as natural sunlight or energy efficient fluorescent lights should be avoided when manually programming the remote control.

Any button other than the device buttons ,  and  and the  button can be manually programmed.

Manually Programming a Button

- 1 Place the original remote control and the learning remote control roughly 10 mm apart facing 'head-to-head' with each other.
- 2 On the learning remote control press and release the required device button, TV () , satellite () or DVD () as appropriate.
- 3 Press and hold the SET () button on the learning remote control until the red light lights and remains lit, then release the button. The remote control is now in learning mode.





If the red light does not turn on, go back to step 2 and try again.

- 4 On the learning remote control press and release the button that is to be programmed. The red light will flash rapidly.
- 5 On the original remote control, press and hold the button that is to be learned. When the red light on the learning remote control **flashes three times and then remains lit** the code has been learnt. If the red light does not flash, repeat steps 4 and 5.

Note: If step 5 is not completed within 15 seconds the learning remote control will exit learning mode and the light will stop flashing.

- 6 Repeat steps 4 and 5 to program other buttons.
- 7 Once the required buttons have been programmed press the SET () button again on the learning remote control to exit learning mode.

Deleting All Button Programmes for One Device

- 1 Press and release the appropriate device button TV () , satellite () or DVD () to select which device's programs are to be deleted.
- 2 Press and hold the chosen device button together with SET () button until the red light flashes three times.
- 3 All of the programmed buttons for the chosen device have now been cleared of their programming.

Deleting programs from buttons does not delete any three digit brand code which has been entered.

Troubleshooting

| <i>Problem</i> | <i>Solution</i> |
|--|--|
| The red light flashes five times after a button is pressed. | Replace the battery with a new type CR2032 battery. |
| The red light does not flash when any button is pressed. | Replace the battery with a new type CR2032 battery. |
| The red light does not flash when a 'programmed' button is pressed. | The button has not been programmed or has not been programmed correctly. Program the button. |
| The red light flashes when a button is pressed but the TileVision® or device does not respond. | Ensure that the remote control is within three meters of, and pointed at, the TileVision® or piece of equipment. |
| The remote control does not operate a device correctly or some commands are not working. | Try all listed codes for the device as shown in the control code pdfs which are available from the support section of the TileVision® web site or program the buttons from the device's own remote control. |
| During learning the red light does not flash three times or stays on for a long time after pressing a button to be learnt. | Memory is full or a bad capture has occurred. For optimum learning, avoid high levels of ambient light such as natural sunlight or energy efficient fluorescent lights. Try adjusting the position of the remote controls before performing the procedure again. |

Troubleshooting

If the remote control fails to operate after the battery has been installed or replaced.

- A. Gently pull forward the small battery terminal.
- B. Gently raise up both prongs.
- C. Push the battery flat in to the battery compartment, so that it is in contact with both battery terminals for 5 seconds.
- D. Remove the battery and insert the battery at an angle, so it rests on the battery terminal A.

Refit the battery cover and wait 15 seconds before operating the remote control.

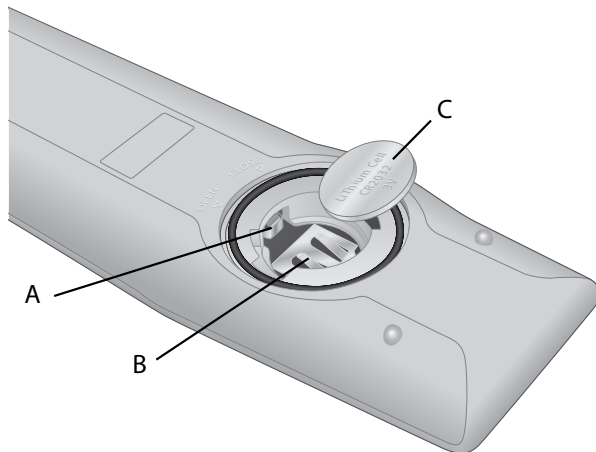

Button Assignment Table

| Programmable Remote Control Button | TileVision® Model/Button Function | | |
|------------------------------------|-----------------------------------|----------------------------|---|
| | TV19/FR1 TV26/FR1 - 371 | TV17/FR5 TV23/FR3 - 369 | TV17/FR4 /FR3 /FR2 TV23/FR2 /FR1 - 370 |
| Power On/Off | Power On/Off | Power On/Off | Power On/Off |
| Number buttons 0–9 | Number buttons 0–9 | Number buttons 0–9 | Number buttons 0–9 |
| Volume Up/Down | Volume Up/Down | Volume Up/Down | Volume Up/Down |
| Programme Up/Down | Programme Up/Down | Programme Up/Down | Programme Up/Down |
| Input Source | Input Source | TV/AV | TV/AV |
| EPG | EPG | EPG | No Function |
| FastText/DTV Text | FastText/DTV Text | FastText/DTV Text | FastText |
| Fast Rewind | Picture Mode | No Function | Picture Memory |
| Pause | Sound Mode | No Function | Sound Memory |
| Play | Aspect Ratio | Previous Channel | Aspect Ratio |
| Fast Forward | Info | Info | Sub Page/Time |
| Text | Text | Text | Text |
| Mute | Mute | Mute | Mute |
| Menu | Menu | Menu | Menu |
| Up | Up | Up | Up |
| Down | Down | Down | Down |
| Left | Left | Left | Left |
| Right | Right | Right | Right |
| OK | OK | OK | OK |
| EXIT | EXIT | No Function | No Function |
| Sub | Subtitles | No Function | No Function |



Porter Lancastrian Limited

Lower Healey Business Park · Froom Street · Chorley
Lancashire · UK · PR6 9AR

Tel: 0870 871 0111 · Fax: 0870 871 0112
eMail: sales@porta.co.uk · Web: www.tilevision.tv